

VocoPro[®]

PROFESSIONAL VOCAL SYSTEMS[™]

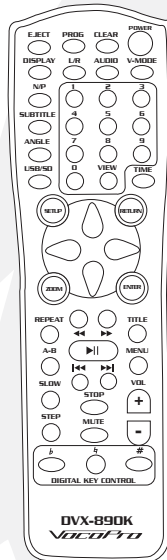

DVX-890K

Multi-Format Digital Key Control Karaoke DVD/DivX[®] Player

o w n e r ' s m a n u a l

Table of Contents

Safety Instructions	4
FCC Information	5
Welcome.	6
Listening for a Lifetime	7
Specifications and Features	8
Mounting the DVX-890K	9
Getting Connected	10
Audio Connections	10 - 11
Video Connections	12
Microphone Connections	13
Descriptions and Functions	14
Front Panel	14
Rear Panel	15
Remote Control	16 - 17
Basic Operations	18 - 19
Advanced Operations.	20 - 21
Karaoke Operations	22
DVD Operations	23
Mp3 Operations	24
Setting up Preferences	25 - 29
Troubleshooting	30

Safety Instructions



CAUTION RISK OF SHOCK



CAUTION: To reduce the risk of electric shock, do not remove cover (or back). No user-serviceable parts inside. Only refer servicing to qualified service personnel.

Explanation of Graphical Symbols



The lightning flash & arrowhead symbol, within an equilateral triangle, is intended to alert you to the presence of danger.



The exclamation point within an equilateral triangle is intended to alert you to the presence of important operating and servicing instructions.

WARNING

To reduce the risk of fire or electric shock, do not expose this unit to rain or moisture.

- 1. Read Instructions** - All the safety and operating instructions should be read before the appliance is operated.
- 2. Retain Instructions** - The safety and operating instructions should be retained for future reference.
- 3. Heed Warnings** - All warnings on the appliance and in the operating instructions should be adhered to.
- 4. Follow Instructions** - All operating and use instructions should be followed.
- 5. Attachments** - Do not use attachments not recommended by the product manufacturer as they may cause hazards.
- 6. Water and Moisture** - Do not use this unit near water. For example, near a bathtub or in a wet basement and the like.
- 7. Carts and Stands** - The appliance should be used only with a cart or stand that is recommended by the manufacturer.
- 7 A.** An appliance and cart combination should be moved with care. Quick stops, excessive force, and uneven surfaces may cause an overturn.



- 8. Ventilation** - The appliance should be situated so its location does not interfere with its proper ventilation. For example, the appliance should not be situated on a bed, sofa, rug, or similar surface that may block the ventilation slots.
- 9. Heat** - The appliance should be situated away from heat sources such as radiators, heat registers, stoves, or other appliances (including amplifiers) that produce heat.
- 10. Power Sources** - The appliance should be connected to a power supply only of the type described in the operating instructions or as marked on the appliance.
- 11. Grounding or Polarization** - Precautions should be taken so that the grounding or polarization means of an appliance is not defeated.
- 12. Power-Cord Protection** - Power-supply cords should be routed so that they are not likely to be walked on or pinched by items placed upon or against them, paying particular attention to cords at plugs, convenience receptacles, and the point where they exit from the appliance.
- 13. Cleaning** - Unplug this unit from the wall outlet before cleaning. Do not use liquid cleaners or aerosol cleaners. Use a damp cloth for cleaning.
- 14. Power lines** - An outdoor antenna should be located away from power lines.
- 15. Nonuse Periods** - The power cord of the appliance should be unplugged from the outlet when left unused for a long period of time.
- 16. Object and Liquid Entry** - Care should be taken so that objects do not fall and liquids are not spilled into the enclosure through openings.
- 17. Damage Requiring Service** - The appliance should be serviced by qualified service personnel when:
 - A. The power supply cord or plug has been damaged; or
 - B. Objects have fallen into the appliance; or
 - C. The appliance has been exposed to rain; or
 - D. The appliance does not appear to operate normally or exhibits a marked change in performance; or
 - E. The appliance has been dropped, or the enclosure damaged.
- 18. Servicing** - The user should not attempt to service the appliance beyond that described in the operating instructions. All other servicing should be referred to qualified service personnel.

Note:

To CATV system installer's (U.S.A.): This reminder is provided to call the CATV system installer's attention to Article 820-40 of the NEC that provides guidelines for proper grounding and, in particular, specifies that the cable ground shall be connected as close to the point of cable entry as practical.

FCC Information

1. IMPORTANT NOTICE: DO NOT MODIFY THIS

UNIT!: This product, when installed as indicated in the instructions contained in this manual, meets FCC requirements. Modifications not expressly approved by Vocopro may void your authority, granted by the FCC, to use this product.

2. IMPORTANT: When connecting this product to accessories and/or another product use only high quality shielded cables. Cable(s) supplied with this product **MUST** be used. Follow all installation instructions. Failure to follow instructions could void your FCC authorization to use this product in the U.S.A.

3. NOTE: This product has been tested and found to comply with the requirements listed in FCC Regulations, Part 15 for Class "B" digital devices. Compliance with these requirements provides a reasonable level of assurances that your use of this product in a residential environment will not result in harmful interference with other electronic devices. This equipment generates/uses radio frequencies and, if not installed and used according to the instructions found in the owner's manual, may cause interference harmful to the operation of other electronic devices. Compliance with FCC regulations does not guarantee that interference will not occur in all installations. If this product is found to be the source of interference, which can be determined by turning the unit "Off" and "On", please try to eliminate the problem by using one of the following measures:

Relocate either this product or the device that is being affected by the interference.

Use power outlets that are on different branch (circuit breaker or fuse) circuits or install AC line filter(s).

In the case of radio or TV interference, relocate/reorient the antenna. If the antenna lead-in is 300-ohm ribbon lead, change the lead-in to coaxial type cable.

If these corrective measures do not produce satisfactory results, please contact your local retailer authorized to distribute Vocopro products. If you can not locate the appropriate retailer, please contact Vocopro, 1728 Curtiss Court, La Verne, CA 91750.

CAUTION

The apparatus is not disconnected from the AC power source so long as it is connected to the wall outlet, even if the apparatus itself is turned off. To fully ensure that the apparatus is indeed fully void of residual power, leave unit disconnected from the AC outlet for at least fifteen seconds.

CAUTION:

READ THIS BEFORE OPERATING YOUR UNIT

1. To ensure the finest performance, please read this manual carefully. Keep it in a safe place for future reference.
2. Install your unit in a cool, dry, clean place - away from windows, heat sources, and too much vibration, dust, moisture or cold. Avoid sources of hum (transformers, v motors). To prevent fire or electrical shock, do not expose to rain and water.
3. Do not operate the unit upside-down.
4. Never open the cabinet. If a foreign object drops into the set, contact your dealer.
5. Place the unit in a location with adequate air circulation. Do not interfere with its proper ventilation; this will cause the internal temperature to rise and may result in a failure.
6. Do not use force on switches, knobs or cords. When moving the unit, first turn the unit off. Then gently disconnect the power plug and the cords connecting to other equipment. Never pull the cord itself.
7. Do not attempt to clean the unit with chemical solvents: this might damage the finish. Use a clean, dry cloth.
8. Be sure to read the "Troubleshooting" section on common operating errors before concluding that your unit is faulty.
9. This unit consumes a fair amount of power even when the power switch is turned off. We recommend that you unplug the power cord from the wall outlet if the unit is not going to be used for a long time. This will save electricity and help prevent fire hazards. To disconnect the cord, pull it out by grasping the plug. Never pull the cord itself.
10. To prevent lightning damage, pull out the power cord and remove the antenna cable during an electrical storm.
11. The general digital signals may interfere with other equipment such as tuners or receivers. Move the system farther away from such equipment if interference is observed.

NOTE:

Please check the copyright laws in your country before recording from records, compact discs, radio, etc. Recording of copyrighted material may infringe copyright laws.

Voltage Selector (General Model Only)

Be sure to position the voltage selector to match the voltage of your local power lines before installing the unit.

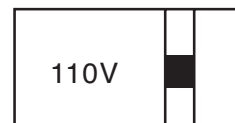



Welcome

And thank you for purchasing the **DVX-890K** from VocoPro, your ultimate choice in Karaoke entertainment! With years of experience in the music entertainment business, VocoPro is a leading manufacturer of Karaoke equipment, and has been providing patrons of bars, churches, schools, clubs and individual consumers the opportunity to sound like a star with full-scale club models, in-home systems and mobile units. All our products offer solid performance and sound reliability, and to reinforce our commitment to customer satisfaction, we have customer service and technical support professionals ready to assist you with your needs. We have provided some contact information for you below.

VocoPro

1728 Curtiss Court
La Verne, CA 91750
Toll Free: 800-678-5348
TEL: 909-593-8893
FAX: 909-593-8890

VocoPro Company Email Directory

Customer Service & General Information

info@vocopro.com

Tech Support

techsupport@vocopro.com

Remember Our Website

Be sure to visit the VocoPro website **www.vocopro.com** for the latest information on new products, packages and promos. And while you're there don't forget to check out our Club VocoPro for Karaoke news and events, chat rooms, club directories and even a KJ Service directory!

We look forward to hearing you sound like a PRO, with VocoPro, the singer's ultimate choice.

FOR YOUR RECORDS

Please record the model number and serial number below, for easy reference, in case of loss or theft. These numbers are located on the rear panel of the unit. Space is also provided for other relevant information

Model Number

Serial Number

Date of Purchase

Place of Purchase

Listening for a Lifetime

Selecting fine audio equipment such as the unit you've just purchased is only the start of your musical enjoyment. Now it's time to consider how you can maximize the fun and excitement your equipment offers. VocoPro and the Electronic Industries Association's Consumer Electronics Group want you to get the most out of your equipment by playing it at a safe level. One that lets the sound come through loud and clear without annoying blaring or distortion and, most importantly, without affecting your sensitive hearing.

Sound can be deceiving. Over time your hearing "comfort level" adapts to a higher volume of sound. So what sounds "normal" can actually be loud and harmful to your hearing. Guard against this by setting your equipment at a safe level BEFORE your hearing adapts.

To establish a safe level:

- Start your volume control at a low setting.
- Slowly increase the sound until you can hear it comfortably and clearly, and without distortion.

Once you have established a comfortable sound level:

- Set the dial and leave it there.
- Pay attention to the different levels in various recordings.

Taking a minute to do this now will help to prevent hearing damage or loss in the future. After all, we want you listening for a lifetime.

Used wisely, your new sound equipment will provide a lifetime of fun and enjoyment. Since hearing damage from loud noise is often undetectable until it is too late, this manufacturer and the Electronic Industries Association's Consumer Electronics Group recommend you avoid prolonged exposure to excessive noise. This list of sound levels is included for your protection.

Some common decibel ranges:

Level	Example
30	Quiet library, Soft whispers
40	Living room, Refrigerator, Bedroom away from traffic
50	Light traffic, Normal Conversation
60	Air Conditioner at 20 ft., Sewing machine
70	Vacuum cleaner, Hair dryer, Noisy Restaurant
80	Average city traffic, Garbage disposals, Alarm clock at 2 ft.

The following noises can be dangerous under constant exposure:

Level	Example
90	Subway, Motorcycle, Truck traffic, Lawn Mower
100	Garbage truck, Chainsaw, Pneumatics drill
120	Rock band concert in front of speakers
140	Gunshot blast, Jet plane
180	Rocket launching pad

-Information courtesy of the Deafness Research Foundation

Specifications and Features

Specifications

Play mode:	NTSC/PAL/AUTO
Compatible formats:	DVD, DIVX, CD+G, Mp3, VCD, SVCD, DVD-R/RW, DVD+R/RW, CD-R/RW, HDCD
Resolution:	> 500 lines
Video S/N ratio:	> 56dB
Frequency response:	fs 96KHz: 20Hz-20kHz: +/- 1dB
Audio S/N ratio:	> 90dB
Dynamic Range:	> 90dB
Distortion:	< 0.01%
D/A converter:	96 kHz / 24bit
Video output:	1Vp-p (75 Ohms)
S-Video output:	Y: 1Vp-p (75 Ohms) C: 0.3Vp-p (75 Ohms)
Digital audio output:	Coaxial
AC-3:	5.1 channel output, SCART
Power voltage:	~100V-240V 50/60Hz
Power consumption:	< 25W
Dimensions:	17" x 3.3" x 9.1"
Weight:	6.9 lbs.

Features

- Multi-format disc player supports DVD, DivX®, VCD, CD+G, Mp3, Photo-CD, HDCD and CD/DVD-R RW formats for unparalleled media entertainment compatibility
- USB and SD card readers to access your digital library of music
- HDMI output for compatibility with latest TVs and receivers
- Dual ¼" microphone inputs with individual volume controls
- Built-in Echo effect for a more professional vocal sound
- Direct Track Access for immediate song selection and playback
- ±8 step Digital Key Control for changing the key of the music to fit your vocal range via remote or front panel
- Program up to 20 tracks in any order
- Built-in Dolby Digital (AC-3) and Dolby DTS decoders for cinema sound quality
- Progressive Scan player
- Full-function remote control for ease of operation of all system features
- 120V/240V and NTSC/PAL compatible for use worldwide
- Audio Outputs 5.1 Channel, Stereo L/R, Digital Coaxial, Digital Optical, HDMI
- Video Outputs: Component (Y/Pb/Pr), Composite RCA, S-Video, SCART, HDMI

Mounting the DVX-890K

Mounting

Use the included mounting brackets to mount the DVX-890K into a 19" rack case. The DVX-890K requires 2 RUs of available rackspace.

Installing the Mounting Brackets onto the DVX-890K

Position the mounting brackets on the DVX-890K with the tabs facing away from the player. Line up the two holes on the mounting bracket with two holes on the sides of the DVX-890K. Use the included screws to secure the brackets on each side of the DVX-890K.

Mounting the DVX-890K

To mount, carefully place the DVX-890K in the rack space of your case. The DVX-890K takes 4 screws to mount. Make sure holes are aligned evenly. Use an alternating "X" rotation when screwing to ensure even tension and alignment.

You will need:

- 19" Rack Case
- 4 Mount Screws
- Phillips-head Screwdriver

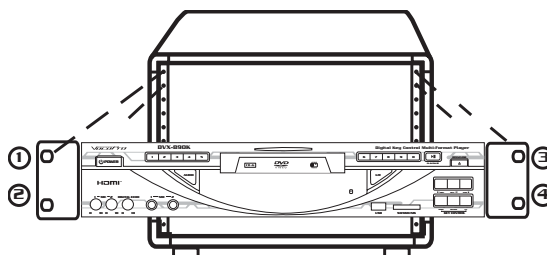
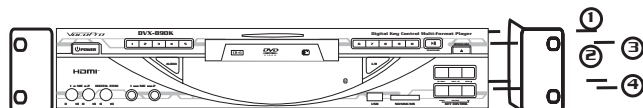

Getting Connected

Audio Connections

FR, FL, CENTER, SL, SR CONNECTION

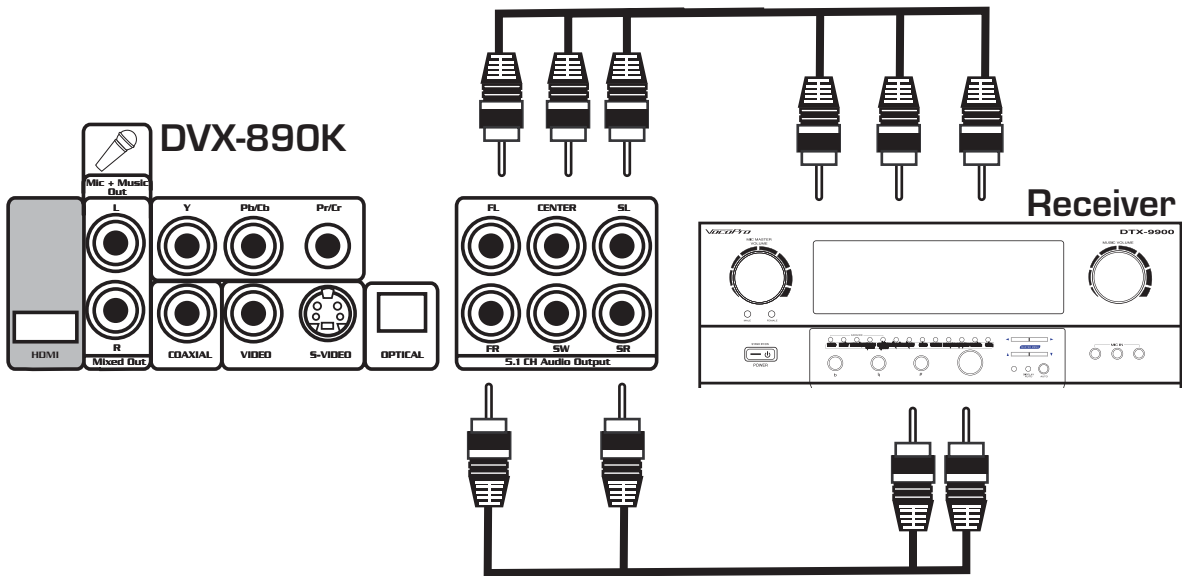

L/R MIX OUTPUT CONNECTION

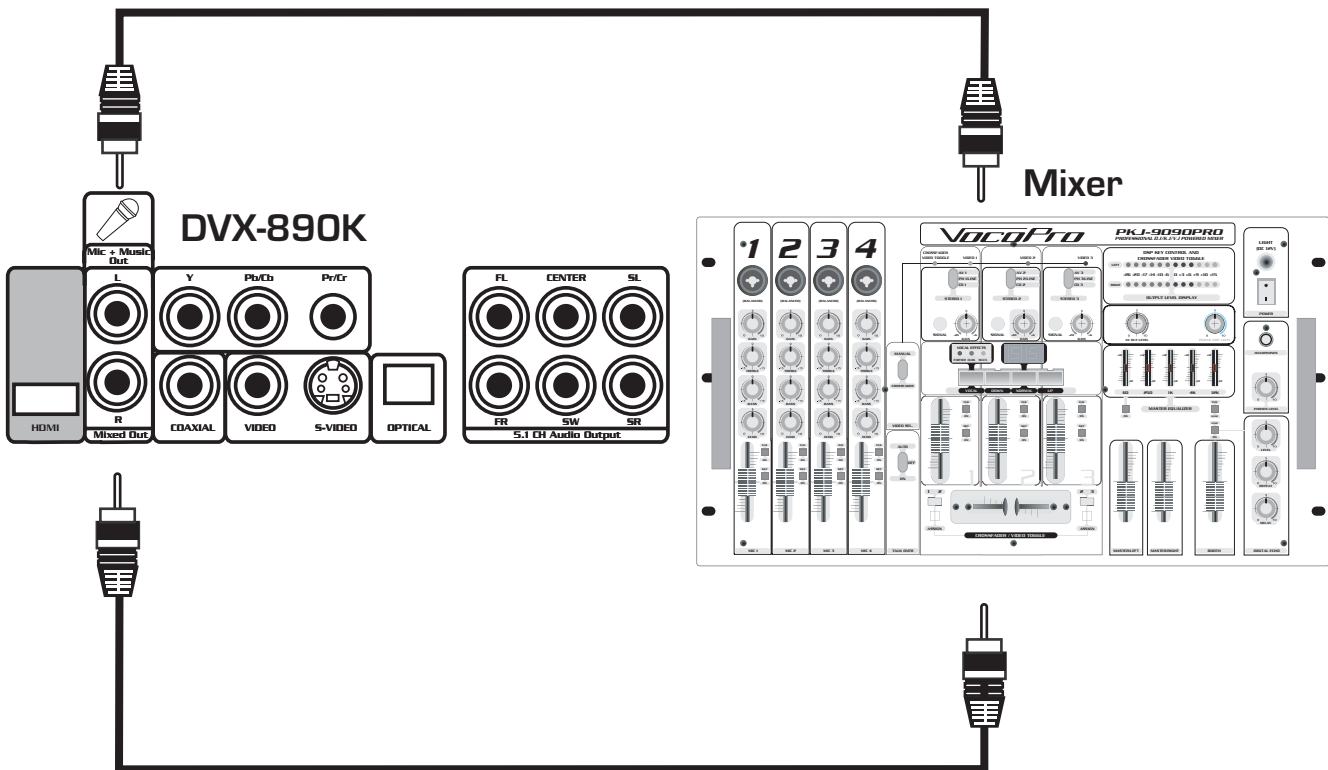

Getting Connected

Audio Connections

DIGITAL/COAXIAL CONNECTION

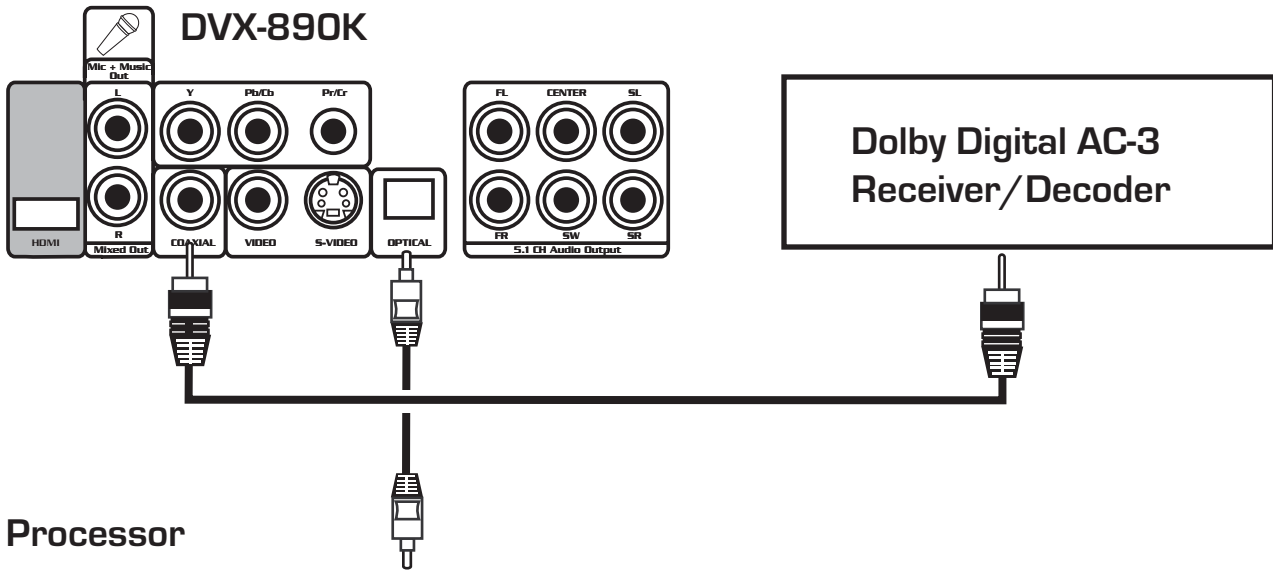

Processor

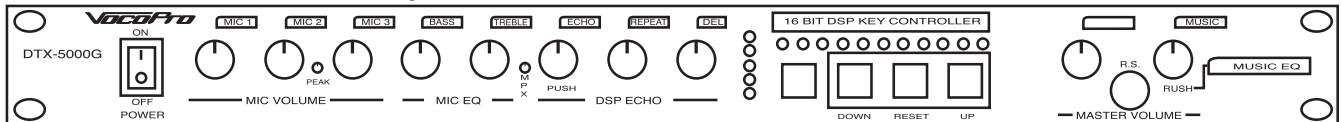

Audio Connections

SUB CONNECTION

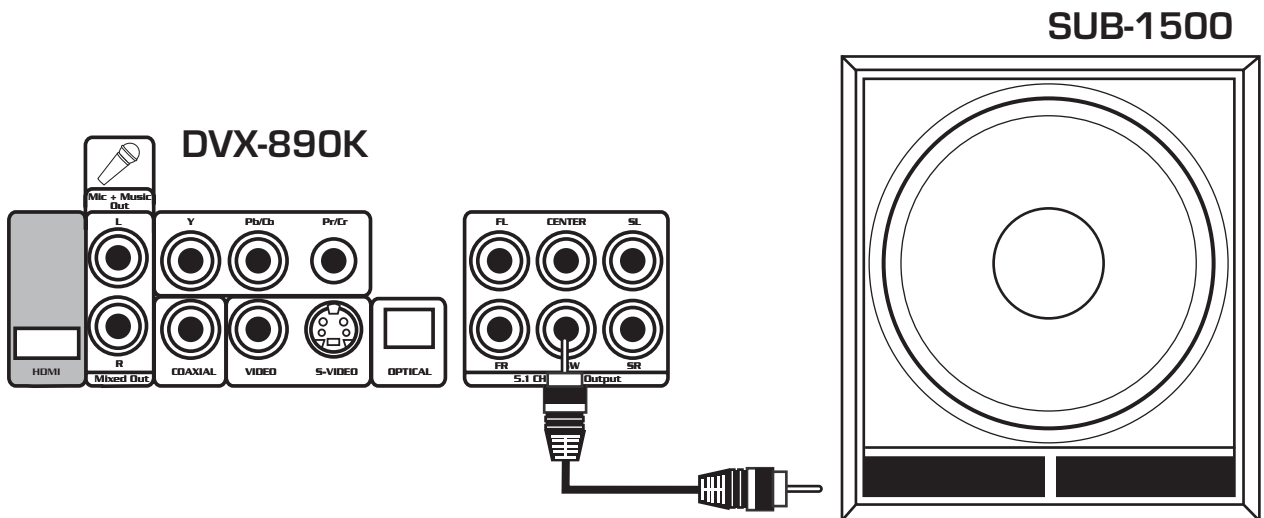

Getting Connected

Video Connections

RCA CONNECTION

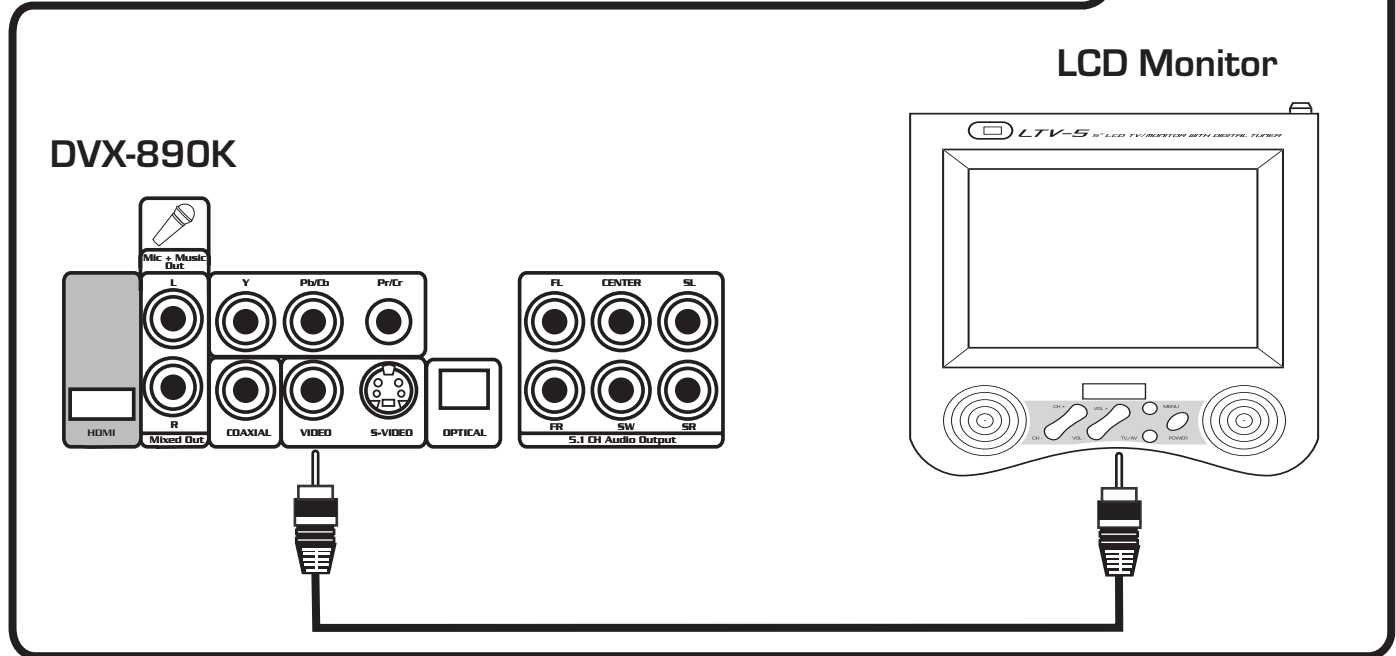

Video Connections

S-VIDEO/Y, Cb, Cr CONNECTION

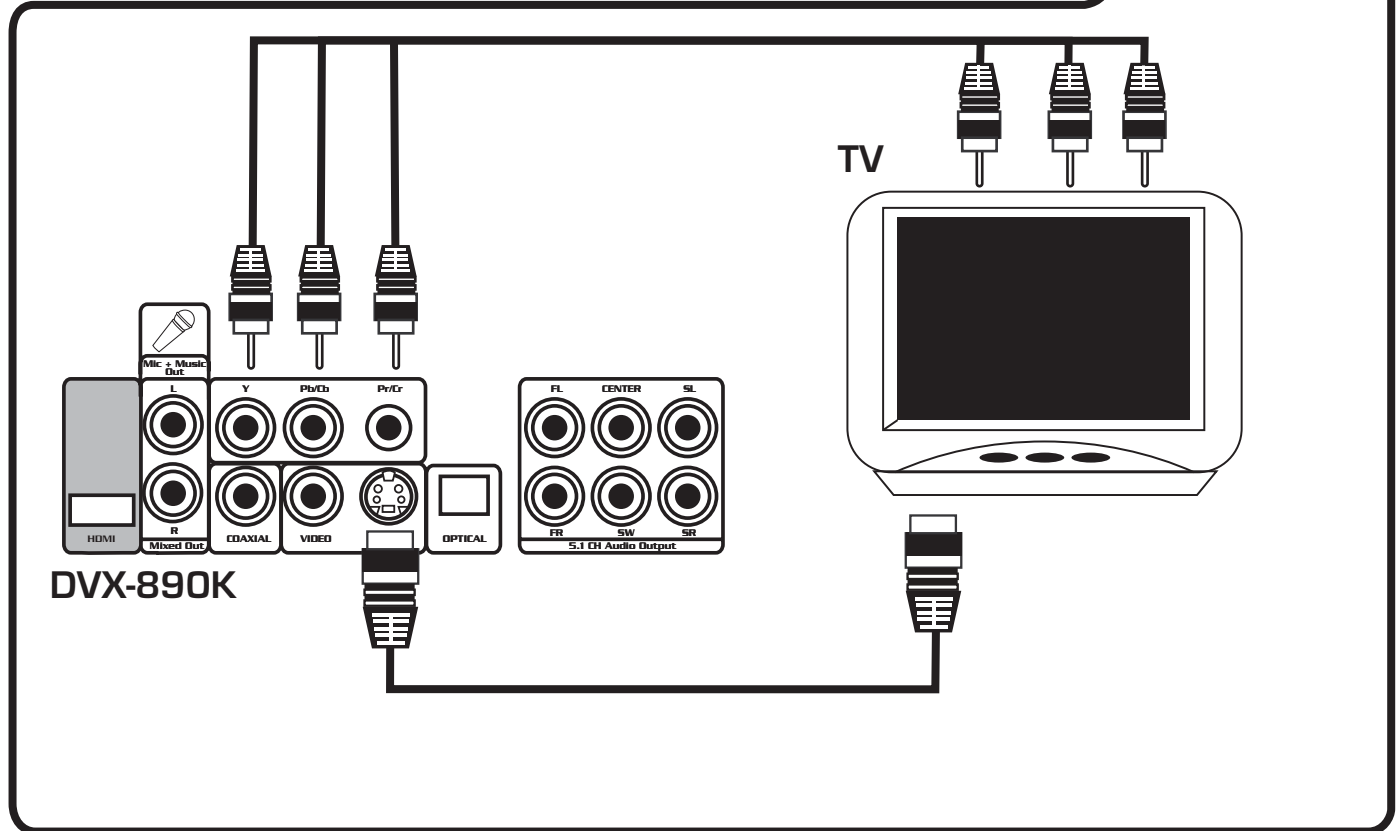

Getting Connected

Setting the correct video mode

Depending on which video connection you are using, you may need to change the **DVX-890K's** video output settings by pressing the **V-MODE** button on the remote control.

The **V-MODE** button toggles between the following modes:

P-Scan: Standard video mode.

SCART: When using the **SCART** output

S-Video: When using the **S-Video** output

YUV: When using the Component outputs

Microphone Connections

MIC CONNECTION

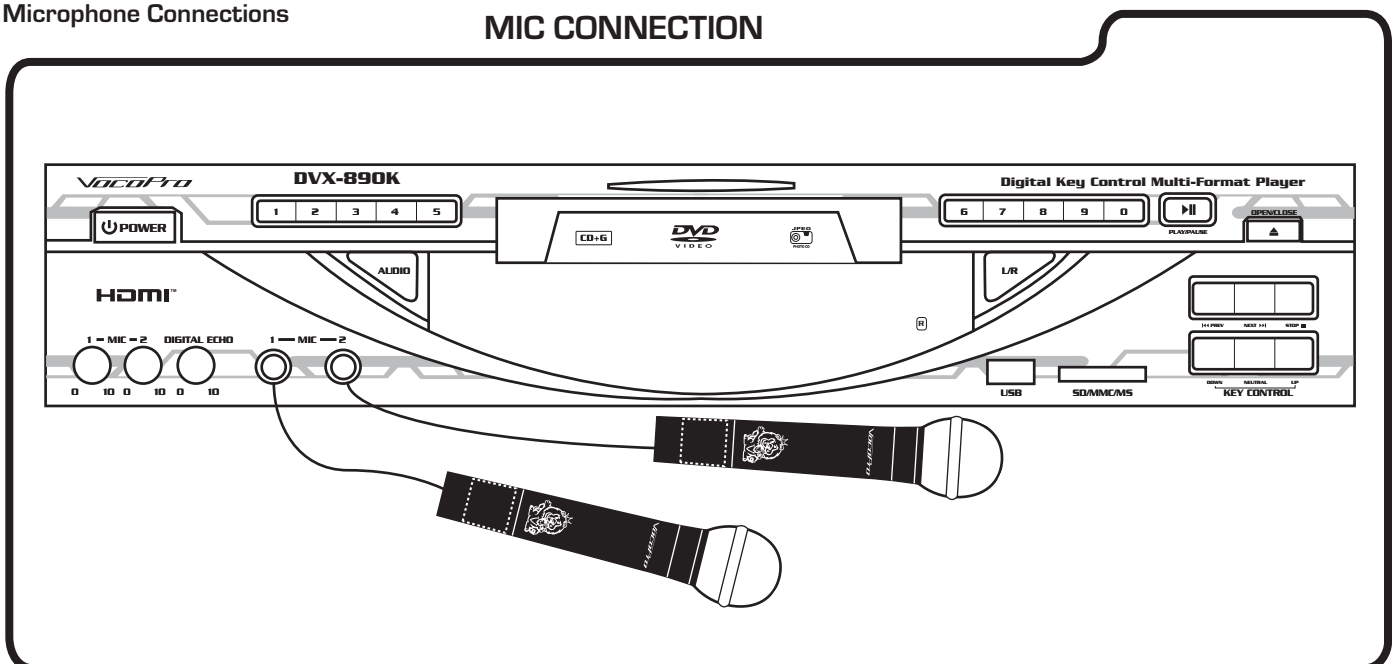

Connect up to two microphones to the DVX-890K, by connecting a 1/4" cable to the MIC 1 and 2 inputs on the DVX-890K.

NOTE: Microphone vocals are only output from the MIC and MUSIC OUT on the rear panel of the DVX-890K. You will not hear the vocals if you are not outputting from these outputs.

Descriptions and Functions

FRONT PANEL

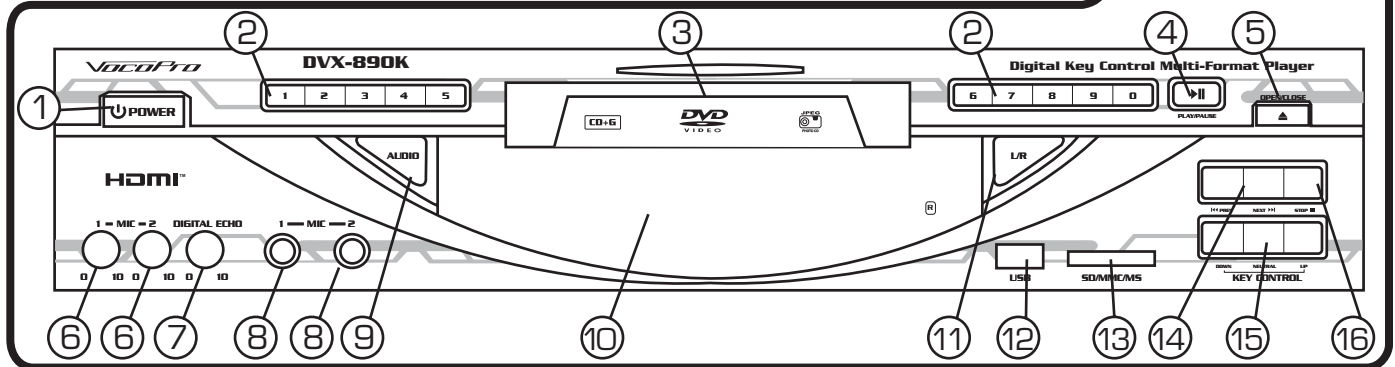

1. **POWER** button - This button turns the unit ON/OFF.
2. **NUMBER PAD** - Press to select a track or file for direct playback.
3. **DISC TRAY** - Insert discs here using the OPEN/CLOSE ▲ button on the player or the EJECT button on the remote control.
4. **PLAY/PAUSE** ▶|| button - PLAYS a disc while it is stopped or paused and PAUSES a disc that is playing.
5. **OPEN/CLOSE** ▲ button - Opens and closes the disc tray.
6. **MIC VOLUME 1** and **2** - Individual volume control for each mic.
7. **ECHO LEVEL** - Controls level of ECHO effect on both mics.
8. **MIC 1** and **MIC 2** inputs - Connect ¼" MIC cables (or line cables for wireless systems) here.
NOTE: Microphone vocals are only output from the MIC and MUSIC OUT on the rear panel of the DVX-890K. You will not hear the vocals if you are not outputting from these outputs.
9. **AUDIO** button - Switch between AC-3 5.1-channel and AC-3 2-channel audio output.
10. **DISPLAY WINDOW** - Shows disc tray status and time display.
11. **L/R** - Switch between four playback modes for multiplex CD+Gs:
LEFT-MONO: Left channel only (no vocals)
RIGHT-MONO: Right channel only (no music)
MIX-MONO: Virtual stereo
STEREO: Left and Right true stereo
12. **USB PORT** - Connect USB thumb drive here.
13. **SD CARD PORT** - Connect SD card here.
14. **PREV / NEXT** buttons - Press these buttons to advance to the NEXT or reverse to the PREVIOUS track.
15. **DIGITAL KEY CONTROL** buttons - UP raises the key and DOWN lowers the key. Natural returns the key to normal.
16. **STOP** button - STOPS a disc that is playing.

Descriptions and Functions

REAR PANEL

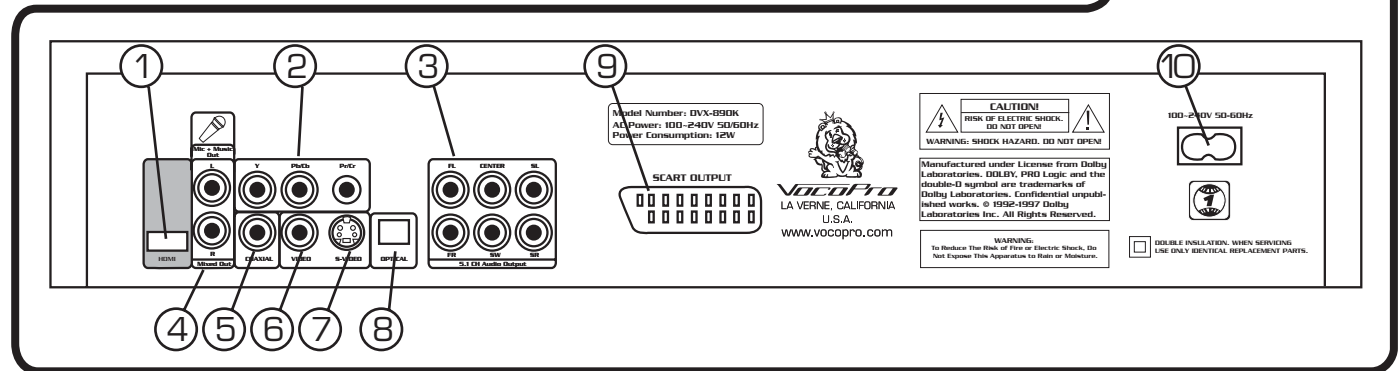

1. **HDMI OUTPUT** jack - This jack is for connecting to HDMI compatible devices.
NOTE: Microphone vocals are only output from the MIC and MUSIC OUT on the rear panel of the DVX-890K.
2. **COMPONENT VIDEO OUT (Y/Pb/Pr)** jacks - These jacks output VIDEO to a TV or monitor via COMPONENT VIDEO cables. COMPONENT VIDEO outputs the different color signals (Pr/Pb) and luminance signal (Y) separately in order to achieve high fidelity in reproducing colors. The description of the component video output connectors may differ depending on the TV set or monitor (e.g. Pr/Pb Y, Cr/Cb/Y, R-Y/B-Y/Y, etc.). Please refer to the operating instructions of the TV set or monitor for details.
3. **5.1 CH. AUDIO OUTPUT** jacks - These jacks are for connecting to 5.1 channel ready amplifiers/receivers.
NOTE: Microphone vocals are only output from the MIC and MUSIC OUT on the rear panel of the DVX-890K.
4. **MIC and MUSIC OUT** jacks - These audio output jacks provide analog AUDIO connections to external devices (A/V receivers, TVs, VCRs etc.). Vocals and music are simultaneously output from these connections.
NOTE: Microphone vocals are only output from the MIC and MUSIC OUT on the rear panel of the DVX-890K. You will not hear the vocals if you are not outputting from these outputs.
5. **DIGITAL COAXIAL AUDIO OUT** jack - This digital output is for connecting devices with a COAXIAL cable.
NOTE: Microphone vocals are only output from the MIC and MUSIC OUT on the rear panel of the DVX-890K.
6. **VIDEO OUT (RCA)** jack - This jack outputs VIDEO to TVs, TFTs and monitors.
7. **S-VIDEO** jack - This jack outputs VIDEO to a display device (TV, TFT, etc.) via an S-VIDEO cable. S-VIDEO provides better color separation and better resolution by separating the color and picture signals of a composite video signal.
8. **DIGITAL OPTICAL AUDIO OUT** jack - This digital out is for connecting devices with an OPTICAL cable. Please make sure to remove the protective cover from this jack prior to connecting an OPTICAL cable. When not using this input, keep the protective cover on to protect it from dust and foreign material.
NOTE: Microphone vocals are only output from the MIC and MUSIC OUT on the rear panel of the DVX-890K.
9. **SCART OUT** - Use this jack for connecting to European TV systems.
10. **AC IN terminal** - Grounded AC power cable connects here.

Descriptions and Functions

REMOTE CONTROL

1. **EJECT** button - Press to **OPEN** and **CLOSE** the disc tray.
2. **PROGRAM** button - Press to access the **PROGRAM** selection window.
3. **DISPLAY** button - To access **OSD** playback display menu. The different **OSD** display modes available depend on the type of disc being played.
4. **L/R** - Switch between four playback modes for multiplex **CD+Gs**:
LEFT-MONO: Left channel only (no vocals)
RIGHT-MONO: Right channel only (no music)
MIX-MONO: Virtual stereo
STEREO - Left and Right true stereo
5. **N/P** - Press to toggle between **NTSC** and **PAL** video settings. Select **NTSC** for North American based video systems and **PAL** for European based video systems.
6. **SUBTITLE** - Press to access the **SUBTITLE** selection window.
7. **ANGLE** - For use only with multi-angle coded discs, for example some recorded performances such as sports events, concerts or theatrical programs. Pressing the button will select various angles of view.
8. **USB/SD** - Press to switch between the disc player, USB or SD card media device for playback.
9. **SETUP** - Press to access the main setup **MENU**.
10. **DIRECTION keys** - Use these buttons to navigate through the various menu selections.
11. **ZOOM** - Increases the size of the lyrics display during **TRACK** playback, or the **SCENE** view on a **DVD**.
12. **B-SCAN / F-SCAN** buttons - These buttons are used to **SCAN** either **BACKWARD** or **FORWARD** through tracks on a disc during playback.
NOTE: Using the **B-SCAN** and **F-SCAN** buttons during the playback of a **CD+G** disc while performing Karaoke is not recommended, as it will cause the onscreen lyrics to scramble.
13. **REPEAT** - Switches between the different repeat modes. The available repeat modes differ depending on what type of disc you are using (i.e. CD+G, Mp3, DivX, etc.).
14. **PLAY / PAUSE** button - Press to initiate disc **PLAYBACK** or **PAUSE** disc playback.
15. **A-B** button - Allows you to loop a certain section of a disc, causing it to repeat continuously.
16. **PREV / NEXT** buttons - Press these buttons to advance to the **NEXT** or reverse to the **PREVIOUS** track.
17. **SLOW** - Press to execute a **SLOW** motion playback of a **DVD** or Video **CD**.

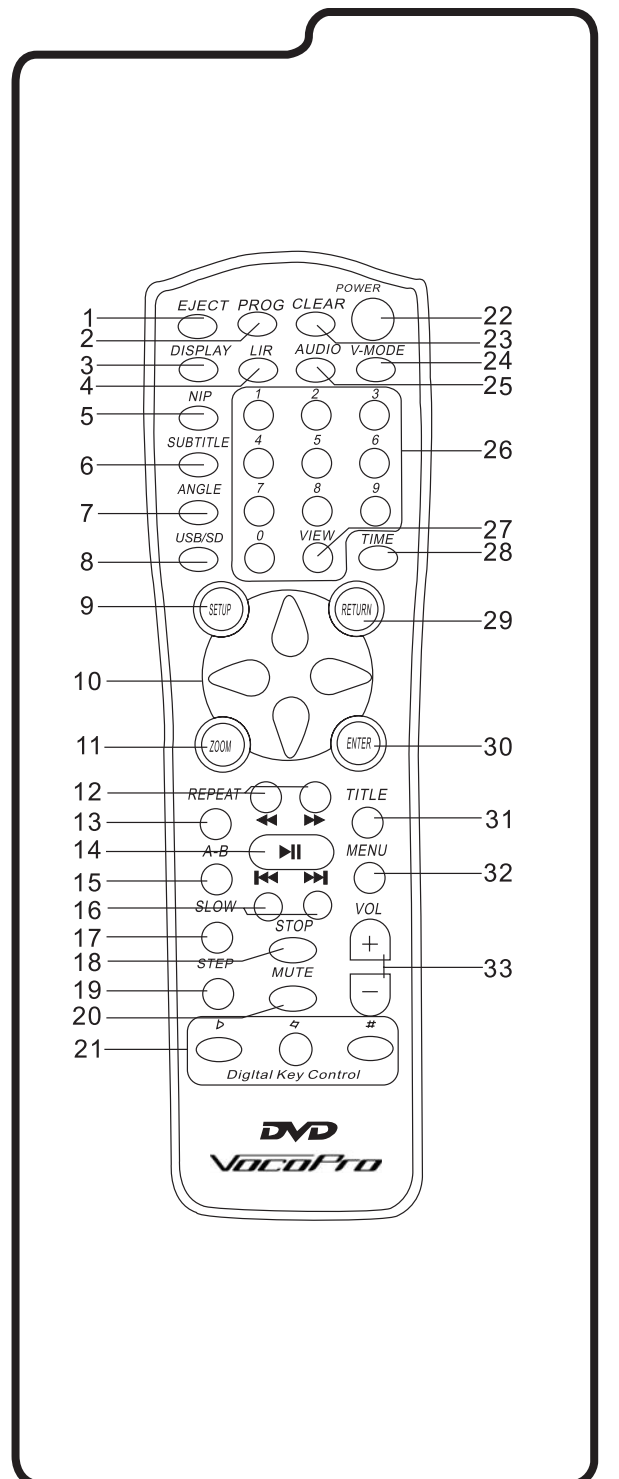

Descriptions and Functions

REMOTE CONTROL CONT.

18. **STOP** button - Press this button once to **PAUSE** playback and enter **AUTO STOP MODE**. Press twice to completely **STOP** playback. While in **AUTO STOP MODE**, playback pauses and the VocoPro splash screen appears. Pressing **PLAY** will resume playback and exit **AUTO STOP MODE**.
19. **STEP** - Press this button to enter **STEP** mode playback. In **STEP** mode, playback is paused and the track/scene advances one frame each time **STEP** is pressed. To exit **STEP** mode, hit the **PLAY** button.
20. **MUTE** button - Press to **SILENCE** audio playback. Video playback is not affected while using the menu feature.
21. **DIGITAL KEY CONTROL** buttons - These buttons direct the **DIGITAL KEY CONTROLLER**
 - # - Raises the musical key a half step each time it is pressed.
 - b - Resets the musical key to it's original key.
 - b - Lowers the musical key a half-step each time it is pressed.
22. **POWER** button - Press to turn machine **ON/OFF**.
23. **CLEAR** - Cancels **PROGRAM** function.
24. **V-MODE** - To select video signal output selections for **RGB, S-Video** and **YUV**.
25. **AUDIO** button - Switch between **AC-3 5.1-channel** and **AC-3 2-channel** audio output.
26. **NUMBER** pad - Press to select a track or file for direct playback.
27. **VIEW** - When using **VCDs**, this button will give you 4 options: **INTRO, DISC, TRACK** and **EXIT**. The 3 menus will show up to 9 **TRACKS** or sections to view.
28. **TIME** - Press this button to view the current disc or track position or to manually input a time to start playback from.
29. **RETURN** - For use with **VCDs**, this button will return to previous menu or page.
30. **ENTER** - To make menu selections or play selected tracks.
31. **TITLE** - Press to access the **TITLE MENU** of a **DVD, VCD** or media disc. Press again to return back to disc playback. If the **TITLE MENU** button is pressed during disc playback, playback is paused. Upon exiting the **TITLE MENU**, playback is resumed.
32. **MENU** - Press to access the menu of a **DVD, VCD** or media disc. Press again to return back to disc playback. If the **MENU** button is pressed during disc playback, playback is paused. Upon exiting the **MENU** window, playback is resumed.
33. **VOLUME** **-/+** keys - Press this button to **RAISE** or **LOWER** the master music **VOLUME**.

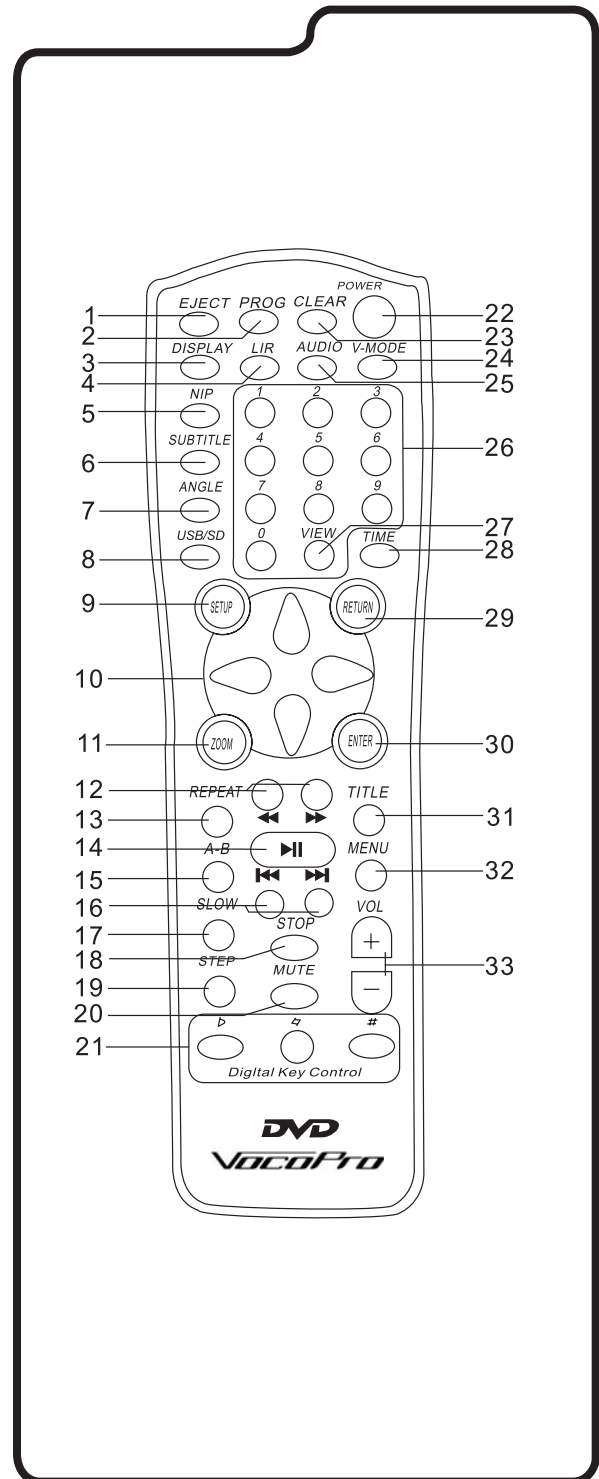

Basic Operations

Before powering on the DVX-890K

- Make sure the power cord is connected to the machine and a power outlet.
- If you are using a power strip/surge protector, make sure that it is switched on.
- Make sure all components (TV, mixer, sound system etc.) are already connected.

Turning on the Power

Press the **POWER** button on the **DVX-890K** or on its remote control.

Inserting a disc

1. Open the disc tray by pressing the **OPEN/CLOSE** button on the player or the **EJECT** button on the remote.
2. Insert the disc label side up.
3. Close the disc tray by pressing the **OPEN/CLOSE** button on the player or the **EJECT** button on the remote.

CD/CD+G disc - The disc will automatically begin playing.

DVD/VCD disc - The movie menu will show up on the screen.



Mp3/DivX disc - The Mp3/DivX menu will appear on the screen.

Playing a disc

NOTE: Discs will automatically begin playing when they are loaded into the disc tray.

To play a stopped disc, press the **PLAY/PAUSE** button on the player or on the remote control.

Skipping tracks on a disc

Skip forwards and backwards to tracks using the **PREV.** and **NEXT** ( and ) buttons on the player or on the remote.

PREV () skips backwards to the previous track.

NEXT () skips forwards to the next track.

Inserting a USB flash drive or SD card

USB:

1. Connect the USB drive to the USB port on the front panel.
2. If there is a disc in the tray or an SD card connected, you may have to press the USB/SD button on the remote control.
3. The Mp3/DivX menu will appear on the screen.

SD card:

1. Connect the SD card to the SD port on the front panel. Be sure to insert it correctly, with the metal contacts facing downward.
2. If there is a disc in the tray or a USB drive connected, you may have to press the USB/SD button on the remote control.
3. The Mp3/DivX menu will appear on the screen.

Basic Operations

Scanning Through Tracks on a Disc

Scan forwards and backwards through tracks using the ◀◀ and ▶▶ buttons on the remote control.

- ◀◀ - Rewinds through a track
- ▶▶ - Fast-forwards through a track

Using the Direct Track Access feature

Jump directly to tracks by using the number pad on the player or on the remote control.

- To jump to track **1** press "0", "1" and then **ENTER**
- To jump to track **22** press "2", "2" and then **ENTER**

Using the Repeat function

Switch between repeat functions by pressing the **REPEAT** button on the player or on the remote control.

- TRACK** repeat - Repeats the same track again
- ALL** repeat - Repeats an entire disc again, after it has finished

Using the slow-motion feature

Press the **SLOW** button on the remote to toggle between the 8 different slow-forward and slow-rewind options:

- |> 1/2 - Plays forwards at 1/2 the normal speed
- |> 1/4 - Plays forwards at 1/4 the normal speed
- |> 1/8 - Plays forwards at 1/8 the normal speed
- |> 1/16 - Plays forwards at 1/16 the normal speed

- <| 1/2 - Rewinds at 1/2 the normal speed
- <| 1/4 - Rewinds at 1/4 the normal speed
- <| 1/8 - Rewinds at 1/8 the normal speed
- <| 1/16 - Rewinds at 1/16 the normal speed

Advanced Operations

Jumping to a specific time in a track or chapter

Press the **TIME** button on the remote twice to access the time menu.
Use the number pad to enter the exact time to skip to.

For example:

To jump to **:30** seconds in a track while it is playing

1. Press **TIME** twice
2. Press "0", "0", "0", "3", "0"

To jump to **2:50** in a track while it is playing

1. Press **TIME** twice
2. Press "0", "0", "1", "5", "0"

Programming tracks/Chapters

Program Menu

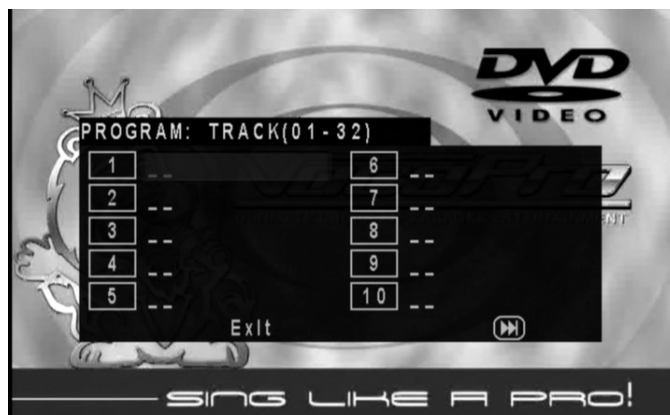

You can program up to **20** tracks on a **CD** or chapters in a movie to play in a different order than which they appear on the disc.

1. Press the **PROGRAM** button on the remote to access the program menu.
2. In each slot, enter the track number that you want to play at that order.

NOTE: For numbers **1 - 9**, you must press "0" and then the track number. For example, track **2** would be "0" and then "2".

Advanced Operations

Using the STEP feature

The **STEP** feature lets you skip through frames, one frame at a time.

Press the **STEP** button on your remote to advance frames. Press the **▶|| (play)** button on the remote to exit step mode.

Looping portions of music or video using the A-B feature

1. Press the **A-B** button on the remote control once at the starting-point of the loop.
2. Press the **A-B** button again at the ending-point of the loop. The loop will automatically begin playing.
3. Press the **A-B** button a third time to cancel the loop.

Karaoke Operations

Digital Key Control

Digital Key Control allows you to raise and lower the key of the music to fit any singer's vocal range.

Change the key by using the **UP** and **DOWN** buttons on the player or the "**b**", [**4**] and "**#**" buttons on the remote.

- Raises the musical key a half-step each time it is pressed.

4 - Resets the musical key to its original key.

b - Lowers the musical key a half-step each time it is pressed.

Removing the vocal track from Multiplex CD+G discs.

NOTE: Vocals can only be removed on Multiplex format **CD+G** discs.

Remove vocals by pressing the **L/R** button on the player or on the remote.
This switches between four settings:

LEFT-MONO: Left channel only (no vocals)

RIGHT-MONO: Right channel only (no music)

MIX-MONO: Virtual stereo

STEREO: Left and Right true stereo

Multiplex discs have music on one channel and vocals on the other.

Choosing the music channel only will eliminate the vocals. Use stereo (**L/R**) for regular discs.

DVD Operations

Accessing the DVD menu

Press the **MENU** button on the remote while the **DVD** is playing.

Use the arrow buttons on the remote to navigate through the menu and use the **ENTER** button to make selections.

Turning on Subtitles

Press the **SUBTITLE** button on the remote control to access subtitles on **DVDs** with subtitle available.

NOTE: Not all **DVDs** have subtitles available.

Changing the screen angle

Press the **ANGLE** button on the remote control to switch between a **DVD's** different viewing angles.

NOTE: Not all **DVDs** have multiple viewing angles

Zooming in and out

Press the **ZOOM** button on the remote control to toggle between the different zoom options:

2X - Zooms in 2x the original size

3X - Zooms in 3x the original size

4X - Zooms in 4x the original size

1/2 - Zooms out 1/2 the original size

1/3 - Zooms out 1/3 the original size

1/4 - Zooms out 1/4 the original size

Mp3 Operations

The Mp3 Menu will appear when an Mp3 disc, USB flash drive or SD card is loaded into the DVX-890K. If there is more than one music source loaded, (ex: a disc, and an SD card), press the USB/SD button on the remote to toggle between the loaded sources. Use the arrow keys on the remote control to navigate through the menu and use the ENTER button to open files and select songs.

Mp3 Repeat options

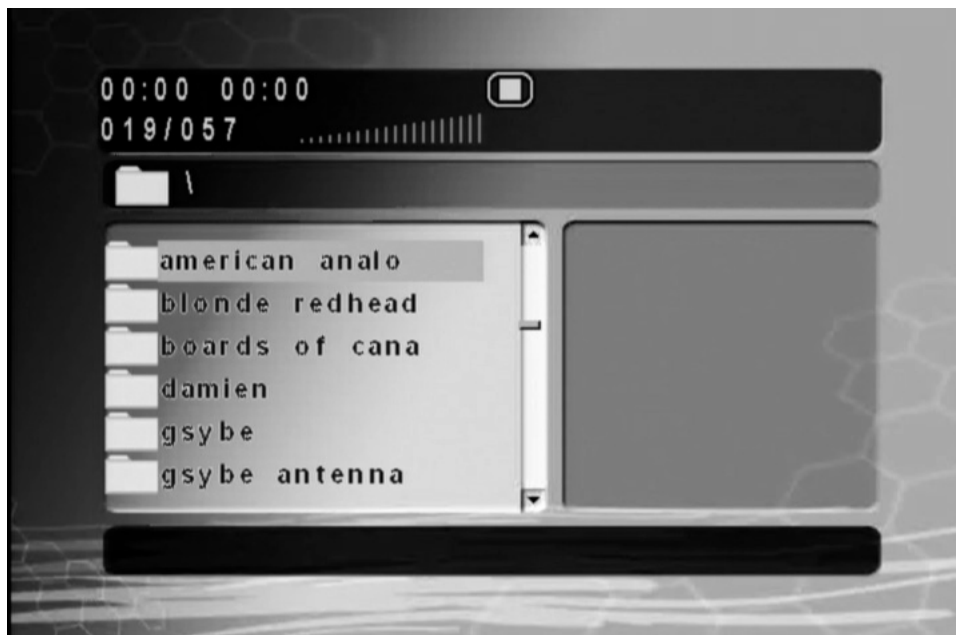

Use the **REPEAT** button on the remote to toggle between the 6 repeat options:

FOLDER:

Plays the whole folder once.

SHUFFLE:

Plays all the songs in a folder, in random order without repeating the same song twice. Playback is stopped when all of the songs in a folder have been played once.

RANDOM:

Plays all the songs in a folder, in random order and will repeat songs more than once. Playback is continuous.

SINGLE:

Repeats the same song continuously.

REPEAT ALL:

Repeats the whole disc.

REPEAT FOLDER:

Repeats the folder continuously.

Setting Up Preferences

General

TV Display: Normal/PS-Normal/Lb-Wide

Normal/PS: Select to view the standard 4:3 picture or the cut standard 4:3 picture.

Normal/LB: Select to view 4:3 standard with letterbox for a full wide-screen mode.

Wide: Select to view widescreen picture with a widescreen capable TV.

Angle Mark: On-Off

On: The angle mark will appear on screen when multiple angles are available for viewing (DVD Only).

Off: The angle mark will not appear.

OSD Lang: English-French-German-Spanish-Italian

Selects the language for the OSD menu.

Captions: On-Off

On: Subtitles will appear onscreen when DVD subtitles are available and selected.

Off: Subtitles will not be displayed.

Screen Saver: On-Off

On: The screen saver will appear after 1 minute of screen/function inactivity.

Off: The screen saver is off, and will not appear.

Last Memory: On-Off

On: The unit will remember the position of the disc (if still in tray), and start playback from that point when the unit is turned back on.

Off: Last memory function disabled.

Setting Up Preferences

Audio

Speaker Setup:

Downmix: lt/rt-stereo-5.1ch

LT/RT: Select when connecting to a Dolby Digital amplifier.

Stereo: Select when connecting to a 2-channel stereo amplifier/mixer.

5.1 CH: Select when using the 5.1 channel outputs on the rear panel.

Front speaker: Large-Small

Large/Small: Select the size that matches your front speakers. (If set to small, low frequency audio will be routed to a subwoofer, if connected.)

Center speaker: Large-Small-Off

Large/Small: Select the size that matches your center speaker.

Off: Select if you do have a center speaker connected. (If set to off, center channel audio will be routed to the front speakers.)

Rear speaker: Large-Small-Off

Large/Small: Select the size that matches your rear speakers.

Off: Select if you do have rear speakers connected.

Subwoofer: on-off

On/Off: Select On if you have a subwoofer connected.

Test tone: on-off

On: When set to on, the unit will generate a test tone to all 5.1 channels for speaker connectivity troubleshooting.

Off: Disables the test tone.

Post drc: on-off-auto

On: Boosts the compressed audio signal, to a nominal level.

Off: Does not boost the compressed audio signal.

Auto: Will boost the compressed audio only when low-level signal is detected.

Spdif Setup:

Spdif output: spdif off-spdif/raw-spdif/pcm

SPDIF Off: Select to disable SPDIF output.

SPDIF/Raw: Select when connecting to a 5.1 channel digital amplifier (DTS/Dolby Movie.)

SPDIF/PCD: Select when connecting to a 2-channel digital amplifier (Audio CD.)

Lpcm out: 48K, 96K, 192K

Select the sampling rate that matches your disc media and amplifier.

Channel Delay:

Use the arrow keys to set the delay for each speaker channel. Press Enter to accept the changes.

Equalizer:

EQ type: off-rock-pop-live-dance-techno-classic-soft

Select the EQ preset that best suits your disc media.

Bass boost: On-Off

Enables or disables a moderate boost in low frequency audio output.

Super bass: On-Off

Enables or disables a significant boost in low frequency audio output.

Treble boost: On-Off

Enables or disables a moderate boost in high frequency audio output.

Setting Up Preferences

Audio continued

3d Processing:

Pro Logic II:

Pro logic II: off-on-auto

Off: Select when NOT playing Pro-Logic II disc media.

On: Select when playing Pro-Logic II disc media.

Auto: Select to have the unit auto-detect and enable Pro-Logic II when disc media is Pro-Logic II encoded.

Mode: music-movie-pro logic-auto

Music: Select for use with music-based disc media.

Movie Pro-Logic: Select for use with movie-based disc media.

Auto: Select to have the unit auto-detect for best sound.

Panorama: On-Off

On/Off: Enables or disables 3D-like sound effect in the center audio signal.

Dimension: Size-3—Size+3

-3: Select for minimal presence of Panorama effect in the sound stage.

+3: Select for maximum presence of Panorama effect in the sound stage.

Center Width: Level 0 – Level 7

Selects the level to which the center signal is spread to left and right channels for panoramic effect.

Reverb mode: off-concert-living-room-hall-bathroom-cave-arena-church

Select the reverb mode that best suits your listening environment.

Dolby:

Dual Mono: Stereo-L/mono-R/mono-mix/mono

Stereo: Select for standard L/R audio output.

L/Mono: Select for mono audio output with the left channel on both sides.

R/Mono: Select for mono audio output with the right channel on both sides.

Mix/mono: Select for mono audio output to both sides.

Dymanic: off—full

Select level of dynamic range compression to be used (Off for no compression; Full for maximum compression.)

Setting Up Preferences

Video Setup

Component: S-video-YUV-RGB

Set to S-VIDEO if you will be connecting to a TV via the S-VIDEO output. Select either YUV or RGB if you will be connecting to a TV via the YPbPr (Component) outputs. See your TV user's manual to determine which setting to use.

Resolution: 480i—1080p

Use this setting to change the resolution of the HDMI output. See your TV user's manual to determine which setting to use. If you will be using the RCA video output, set this setting to AUTO.

Quality:

Sharpness: high-medium-low

Set the sharpness of the image with this setting.

Brightness: -20—20

Set the brightness of the image with this setting. A negative value will make the image darker.

Contrast: -20—20

Set the contrast of the image with this setting. A higher value will make the light colors lighter and the dark colors darker. A negative value will make the light and dark colors less vibrant.

Gamma: none-low-medium-high

Set the gamma correction with this setting. Gamma correction is similar to brightness.

Hue: -9—9

Set the hue or color of the image with this setting.

Saturation: -9—9

Set the Saturation of the image with this setting. Saturation makes the colors in an image more intense.

Luma Delay: 0T-1T

Set the luma delay of the video signal with this setting. Use this setting only if the image color is fuzzy or shifted to the left.

HDMI Setup:

HDMI: on-off

This setting enables or disables the HDMI output.

Audio source: auto-pcm

This setting switches the HDMI audio output between auto and PCM.

Setting Up Preferences

Preferences

Tv type: ntsc-pal-auto

This setting switches between NTSC, PAL and AUTO. Set to NTSC for the United States and Asia, and PAL for Europe. If you are uncertain what TV type you have, set to AUTO.

Pbc: on-off

Enables the playback control menu for VCDs.

Audio: English-French-German-Italian-Spanish

Switches the language of the audio of a DVD. Note that not all DVD's have all languages available.

Subtitle: English-French-German-Italian-Spanish-off

Switches the language of the subtitles of a DVD. Note that not all DVD's have all languages available.

Disc menu: English-French-German-Italian-Spanish

Switches the language of the menu of a DVD. Note that not all DVD's have all languages available.

Parental: 1—8

Set the parental rating for DVDs.

Password: on-off

Makes the password necessary in order to change the parental settings.

The factory default password is: 136900

To change the password, enter the old password, enter the new password, and confirm the new password, and then press enter.

Default: reset

Restores all of the default factory presets.

Troubleshooting

There is no power

- Make sure the power cord is firmly connected to the back of the **DVX-890K** and to the power outlet.
- If using a power strip/surge-protector, make sure that it is plugged in and switched on.

There is no sound

- Make sure everything is connected firmly and properly.
- Make sure there are no defective cables.
- Make sure all of your components are turned on.
- Make sure all of the components (amp, mixer, TV, etc.) are set to the proper inputs.

No picture

- Make sure everything is connected firmly and properly.
- Make sure there are no defective cables.
- Make sure all of your components are turned on.
- Make sure all of the components (amp, mixer, TV, etc.) are set to the proper inputs.
- Make sure the TV or monitor is working correctly.
- Make sure the **DVX-890K** is set to the correct video output mode using the **V-MODE** button on the remote control.

The disc does not play

- Make sure the disc is inserted correctly (label-side up).
- Make sure the disc is clean and not scratched.
- If using a **CD/DVD R/RW**, try using a different brand as some brands might not be compatible.
- Clean the **CD** lens using a **CD** lens cleaner.

Remote control does not work

- Make sure the batteries are inserted, inserted correctly, and not out of power.
- Point the remote control directly at the remote sensor on the machine.
- Move closer to the machine.

The picture is unclear

- Make sure the disc is not dirty or damaged.
- Make sure that the **TV TYPE (N/P** button on the remote) is set correctly:
 - NTSC:** In North America, Japan and many other Asian countries
 - PAL:** In Europe
- Try restarting the **DVX-890K**.



VocoPro[®]

PROFESSIONAL VOCAL SYSTEMS[™]

