

VocoPro®

PROFESSIONAL VOCAL SYSTEMS™

FEATURES:

- 150W + 150W maximum power output Mixing Amplifier
- ±4 Step Digital Key Controller for transposing natural key of source music
- Digital Echo with Repeat and Delay controls to add depth and space to vocals
- Three Microphone Inputs with individual Volume controls
- Full-function remote control for ease of operation
- Built in AM/FM tuner with 60 programmable station presets
- Master Music and Microphone Volume controls
- Three dedicated RCA L/R audio input channels
- Three RCA Video Inputs and Two Video Outputs

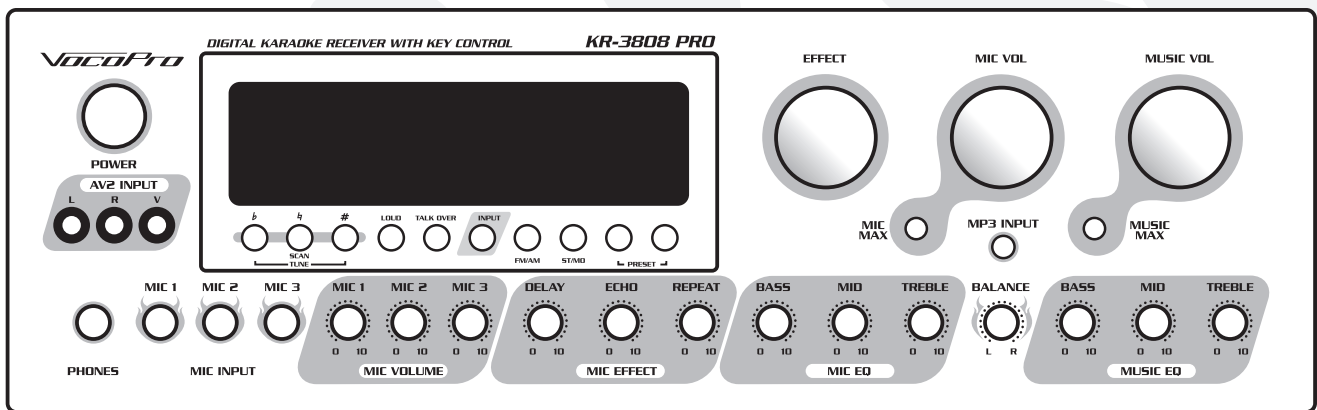
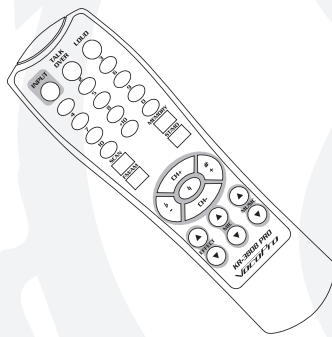

KR-3808 PRO Digital Karaoke Receiver with Key Control

o w n e r ' s m a n u a l

Table of Contents

Introduction

Safety Instructions	2
FCC Information	3
Welcome	4
Listening for a Lifetime	5
Before Getting Started	6

Getting Connected

Remote and Power Cable	7
Speakers.....	8
Connecting Input Source Players.....	9-12
Connecting TV's/Monitors	13

Descriptions and Functions

Front Panel	14-16
Rear Panel	17-18
Remote Control.....	19

Operations.....	20
-----------------	----

Troubleshooting.....	21
----------------------	----

Safety Instructions



CAUTION

RISK OF SHOCK



CAUTION: To reduce the risk of electric shock, do not remove cover (or back). No user-serviceable parts inside. Only refer servicing to qualified service personnel.

Explanation of Graphical Symbols



The lightning flash & arrowhead symbol, within an equilateral triangle, is intended to alert you to the presence of danger.



The exclamation point within an equilateral triangle is intended to alert you to the presence of important operating and servicing instructions.

WARNING

To reduce the risk of fire or electric shock, do not expose this unit to rain or moisture.

1. Read Instructions - All the safety and operating instructions should be read before the appliance is operated.

2. Retain Instructions - The safety and operating instructions should be retained for future reference.

3. Heed Warnings - All warnings on the appliance and in the operating instructions should be adhered to.

4. Follow Instructions - All operating and use instructions should be followed.

5. Attachments - Do not use attachments not recommended by the product manufacturer as they may cause hazards.

6. Water and Moisture - Do not use this unit near water. For example, near a bathtub or in a wet basement and the like.

7. Carts and Stands - The appliance should be used only with a cart or stand that is recommended by the manufacturer.

7 A. An appliance and cart combination should be moved with care. Quick stops, excessive force, and uneven surfaces may cause an overturn.



8. Ventilation - The appliance should be situated so its location does not interfere with its proper ventilation. For example, the appliance should not be situated on a bed, sofa, rug, or similar surface that may block the ventilation slots.

9. Heat - The appliance should be situated away from heat sources such as radiators, heat registers, stoves, or other appliances (including amplifiers) that produce heat.

10. Power Sources - The appliance should be connected to a power supply only of the type described in the operating instructions or as marked on the appliance.

11. Grounding or Polarization - Precautions should be taken so that the grounding or polarization means of an appliance is not defeated.

12. Power-Cord Protection - Power-supply cords should be routed so that they are not likely to be walked on or pinched by items placed upon or against them, paying particular attention to cords at plugs, convenience receptacles, and the point where they exit from the appliance.

13. Cleaning - Unplug this unit from the wall outlet before cleaning. Do not use liquid cleaners or aerosol cleaners. Use a damp cloth for cleaning.

14. Power lines - An outdoor antenna should be located away from power lines.

15. Nonuse Periods - The power cord of the appliance should be unplugged from the outlet when left unused for a long period of time.

16. Object and Liquid Entry - Care should be taken so that objects do not fall and liquids are not spilled into the enclosure through openings.

17. Damage Requiring Service - The appliance should be serviced by qualified service personnel when:

- A. The power supply cord or plug has been damaged; or
- B. Objects have fallen into the appliance; or
- C. The appliance has been exposed to rain; or
- D. The appliance does not appear to operate normally or exhibits a marked change in performance; or
- E. The appliance has been dropped, or the enclosure damaged.

18. Servicing - The user should not attempt to service the appliance beyond that described in the operating instructions. All other servicing should be referred to qualified service personnel.

Note:

To CATV system installer's (U.S.A.): This reminder is provided to call the CATV system installer's attention to Article 820-40 of the NEC that provides guidelines for proper grounding and, in particular, specifies that the cable ground shall be connected as close to the point of cable entry as practical.

FCC INFORMATION (U.S.A.)

1. IMPORTANT NOTICE: DO NOT MODIFY THIS

UNIT!: This product, when installed as indicated in the instructions contained in this manual, meets FCC requirements. Modifications not expressly approved by Vocopro may void your authority, granted by the FCC, to use this product.

2. IMPORTANT: When connecting this product to accessories and/or another product use only high quality shielded cables. Cable(s) supplied with this product **MUST** be used. Follow all installation instructions. Failure to follow instructions could void your FCC authorization to use this product in the U.S.A.

3. NOTE: This product has been tested and found to comply with the requirements listed in FCC Regulations, Part 15 for Class "B" digital devices. Compliance with these requirements provides a reasonable level of assurances that your use of this product in a residential environment will not result in harmful interference with other electronic devices. This equipment generates/uses radio frequencies and, if not installed and used according to the instructions found in the owner's manual, may cause interference harmful to the operation of other electronic devices. Compliance with FCC regulations does not guarantee that interference will not occur in all installations. If this product is found to be the source of interference, which can be determined by turning the unit "Off" and "On", please try to eliminate the problem by using one of the following measures:

Relocate either this product or the device that is being affected by the interference.

Use power outlets that are on different branch (circuit breaker or fuse) circuits or install AC line filter(s).

In the case of radio or TV interference, relocate/reorient the antenna. If the antenna lead-in is 300-ohm ribbon lead, change the lead-in to coaxial type cable.

If these corrective measures do not produce satisfactory results, please contact your local retailer authorized to distribute Vocopro products. If you can not locate the appropriate retailer, please contact Vocopro, 1728 Curtiss Court, La Verne, CA 91750.

CAUTION

The apparatus is not disconnected from the AC power source so long as it is connected to the wall outlet, even if the apparatus itself is turned off. To fully ensure that the apparatus is indeed fully void of residual power, leave unit disconnected from the AC outlet for at least fifteen seconds.

CAUTION:

READ THIS BEFORE OPERATING YOUR UNIT

1. To ensure the finest performance, please read this manual carefully. Keep it in a safe place for future reference.
2. Install your unit in a cool, dry, clean place - away from windows, heat sources, and too much vibration, dust, moisture or cold. Avoid sources of hum (transformers, v motors). To prevent fire or electrical shock, do not expose to rain and water.
3. Do not operate the unit upside-down.
4. Never open the cabinet. If a foreign object drops into the set, contact your dealer.
5. Place the unit in a location with adequate air circulation. Do not interfere with its proper ventilation; this will cause the internal temperature to rise and may result in a failure.
6. Do not use force on switches, knobs or cords. When moving the unit, first turn the unit off. Then gently disconnect the power plug and the cords connecting to other equipment. Never pull the cord itself.
7. Do not attempt to clean the unit with chemical solvents: this might damage the finish. Use a clean, dry cloth.
8. Be sure to read the "Troubleshooting" section on common operating errors before concluding that your unit is faulty.
9. This unit consumes a fair amount of power even when the power switch is turned off. We recommend that you unplug the power cord from the wall outlet if the unit is not going to be used for a long time. This will save electricity and help prevent fire hazards. To disconnect the cord, pull it out by grasping the plug. Never pull the cord itself.
10. To prevent lightning damage, pull out the power cord and remove the antenna cable during an electrical storm.
11. The general digital signals may interfere with other equipment such as tuners or receivers. Move the system farther away from such equipment if interference is observed.

NOTE:

Please check the copyright laws in your country before recording from records, compact discs, radio, etc. Recording of copyrighted material may infringe copyright laws.

Voltage Selector (General Model Only)

Be sure to position the voltage selector to match the voltage of your local power lines before installing the unit.

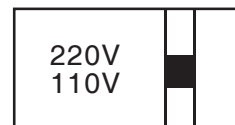



Welcome

And thank you for purchasing the **KR-3808 PRO** from VocoPro, your ultimate choice in Karaoke entertainment! With years of experience in the music entertainment business, VocoPro is a leading manufacturer of Karaoke equipment, and has been providing patrons of bars, churches, schools, clubs and individual consumers the opportunity to sound like a star with full-scale club models, in-home systems and mobile units. All our products offer solid performance and sound reliability, and to reinforce our commitment to customer satisfaction, we have customer service and technical support professionals ready to assist you with your needs. We have provided some contact information for you below.

VocoPro

1728 Curtiss Court
La Verne, CA 91750
Toll Free: 800-678-5348
TEL: 909-593-8893
FAX: 909-593-8890

VocoPro Company Email Directory

Customer Service & General Information

info@vocopro.com

Tech Support

techsupport@vocopro.com

Remember Our Website

Be sure to visit the VocoPro website **www.vocopro.com** for the latest information on new products, packages and promos. And while you're there don't forget to check out our Club VocoPro for Karaoke news and events, chat rooms, club directories and even a KJ Service directory!

We look forward to hearing you sound like a PRO, with VocoPro, the singer's ultimate choice.

FOR YOUR RECORDS

Please record the model number and serial number below, for easy reference, in case of loss or theft. These numbers are located on the rear panel of the unit. Space is also provided for other relevant information

Model Number

Serial Number

Date of Purchase

Place of Purchase

Listening for a Lifetime

Selecting fine audio equipment such as the unit you've just purchased is only the start of your musical enjoyment. Now it's time to consider how you can maximize the fun and excitement your equipment offers. VocoPro and the Electronic Industries Association's Consumer Electronics Group want you to get the most out of your equipment by playing it at a safe level. One that lets the sound come through loud and clear without annoying blaring or distortion and, most importantly, without affecting your sensitive hearing.

Sound can be deceiving. Over time your hearing 'comfort level' adapts to a higher volume of sound. So what sounds 'normal' can actually be loud and harmful to your hearing. Guard against this by setting your equipment at a safe level BEFORE your hearing adapts.

To establish a safe level:

- Start your volume control at a low setting.
- Slowly increase the sound until you can hear it comfortably and clearly, and without distortion.

Once you have established a comfortable sound level:

- Set the dial and leave it there.
- Pay attention to the different levels in various recordings.

Taking a minute to do this now will help to prevent hearing damage or loss in the future. After all, we want you listening for a lifetime.

Used wisely, your new sound equipment will provide a lifetime of fun and enjoyment. Since hearing damage from loud noise is often undetectable until it is too late, this manufacturer and the Electronic Industries Association's Consumer Electronics Group recommend you avoid prolonged exposure to excessive noise. This list of sound levels is included for your protection.

Some common decibel ranges:

Level	Example
30	Quiet library, Soft whispers
40	Living room, Refrigerator, Bedroom away from traffic
50	Light traffic, Normal Conversation
60	Air Conditioner at 20 ft., Sewing machine
70	Vacuum cleaner, Hair dryer, Noisy Restaurant
80	Average city traffic, Garbage disposals, Alarm clock at 2 ft.

The following noises can be dangerous under constant exposure:

Level	Example
90	Subway, Motorcycle, Truck traffic, Lawn Mower
100	Garbage truck, Chainsaw, Pneumatics drill
120	Rock band concert in front of speakers
140	Gunshot blast, Jet plane
180	Rocket launching pad

-Information courtesy of the Deafness Research Foundation

Before Getting Started

Thank you for purchasing the KR-3808 PRO Digital Karaoke Mixing Amplifier. The KR-3808 PRO will provide years of reliability and high quality entertainment for you if used properly. Please read this manual carefully before using your KR-3808 PRO to ensure best performance.

Unpacking the KR-3808 PRO

Carefully remove the KR-3808 PRO from its carton. It is recommended that you store the original packaging materials in case you need to ship this equipment for any reason.

Be sure you have the following parts and components included with your KR-3808 PRO:

ITEMS:	QUANTITY:
KR-3808 PRO	1
Video/Stereo RCA Patch Cable	1
Remote Control	1
AC Power Cable	1
Rack Brackets	2

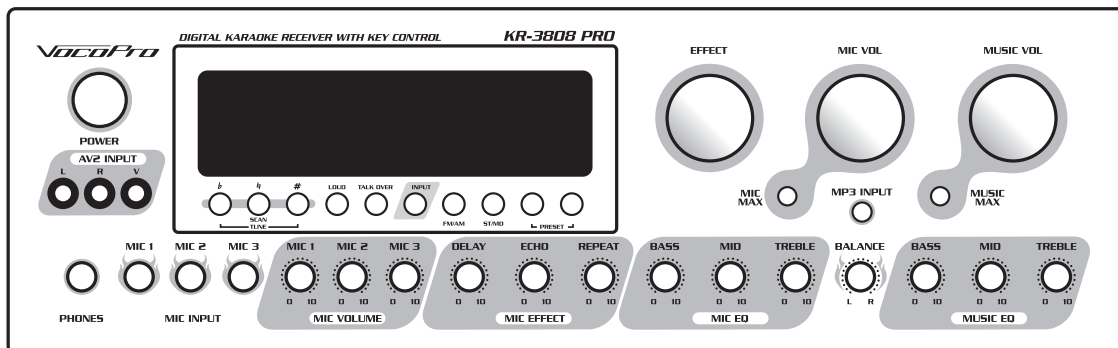
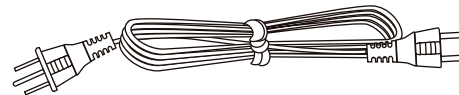
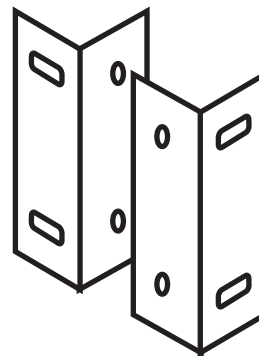
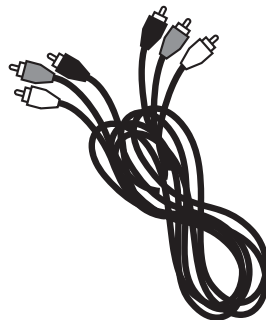
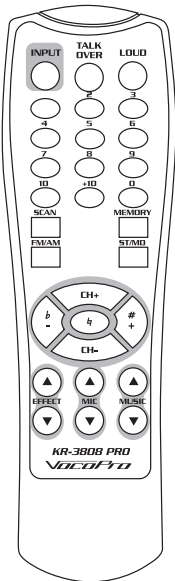

Getting Connected

About the Remote Control

- The area between the remote control and the main unit must be clear of large obstacles.
- Do not expose the remote control sensor to strong lighting, especially an inverter type fluorescent lamp as this may cause the remote control to not function properly.

Installing Batteries in the Remote Control

1. Turn the remote control over and slide the battery compartment cover off towards the direction of the arrow.
2. Insert the AA batteries, positioning them according to the polarity (+, -) markings on the inside of the battery compartment.
3. Close the battery compartment cover.

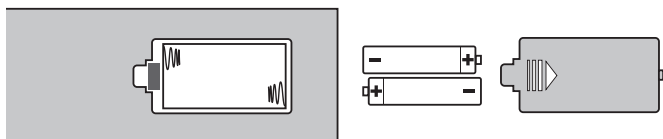

Image shown is a generic model for reference.

Battery Replacement

If you find that the distance between the remote control and the main unit must be shorter in order to use the remote control, this means that the batteries are low and must be changed. Replace both batteries with new ones.

Battery Notes:

- Use AA batteries.
- Be sure the polarities (+, -) are correct. (See the illustration inside the battery compartment).
- Remove the batteries when not using the remote control for an extended period of time.
- If batteries leak, dispose of them immediately. Avoid skin, clothing and any other contact with the leaked material. Clean the battery compartment thoroughly before installing new batteries.
- Do not mix old and new batteries.
- Do not mix alkaline, standard (carbon-zinc) with rechargeable (nickel-cadmium) batteries.

Connecting the Power Cable

Plug the supplied AC power cable into the AC inlet after all other connections are complete and then plug the AC power cable to an AC wall outlet.

CAUTION

Use the supplied AC cable. Do not use other AC power cables as doing so may result in fire hazard or electrical shock.

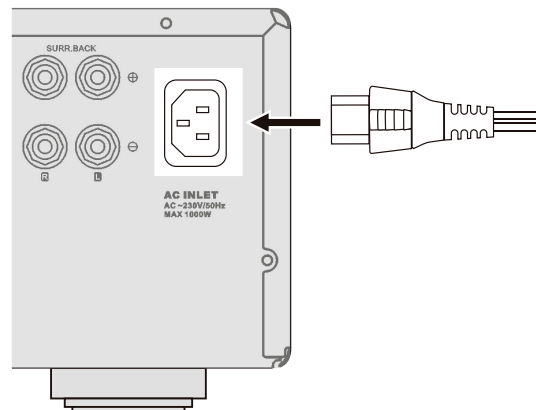

Image shown is a generic model for reference.

Getting Connected

Connecting Speakers

The Speaker Terminals are located on the rear panel. There are two STEREO terminals. Be sure to connect the left channel (L), right channel (R), "+" (red) and "-" (black) properly.

KR-3808 PRO rear panel

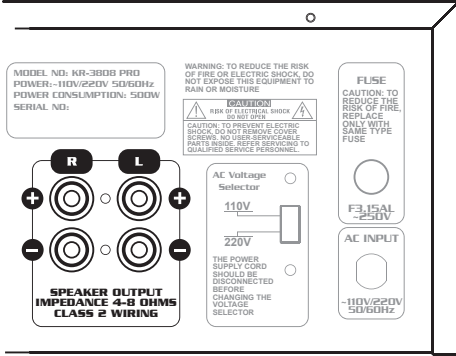

- Before connecting the speakers, make sure that the KR-3808 PRO is disconnected from the power source.
- Do not let the bare speaker wires touch each other or another metal part of this unit. This could damage the KR-3808 PRO and/or the speakers.

Determining the proper way to connect the speaker cables:

The speaker cable is a pair of insulated cables running side by side. One cable is colored or shaped differently, perhaps with a stripe, groove or ridges.

1. Connect one end of the striped (grooved, ridged, etc.) cable to the "+" (red) terminal on the rear panel of the KR-3808 PRO.
2. Connect the other end of the striped (grooved, ridged, etc.) cable to the "+" (red) terminal on the speaker.
3. Connect one end of the "plain" (NO stripes, grooves, ridges, etc.) cable to the "-" (black) terminal on the rear panel of the KR-3808 PRO.
4. Connect the other end of the "plain" (NO stripes, grooves, ridges, etc.) cable to the "-" (black) terminal on the speaker.

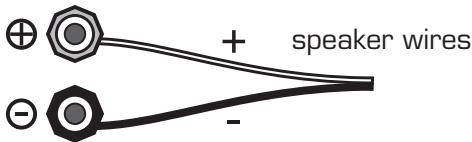

KR-3808 PRO connectors

Preparing the Speaker Cable

You can either use an exposed speaker wire or Banana Plug speaker cable.

Exposed Speaker Wire

1. Remove approximately 3/8" (10mm) of insulation.

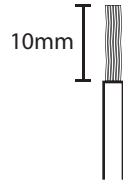

2. Twist the exposed wires together to prevent short circuits.

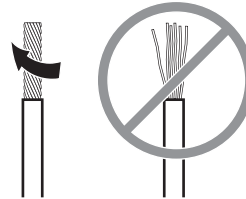

3. Loosen the knob on the speaker terminal.
4. Insert the bare wire.
5. Tighten the knob until the wire is secure.

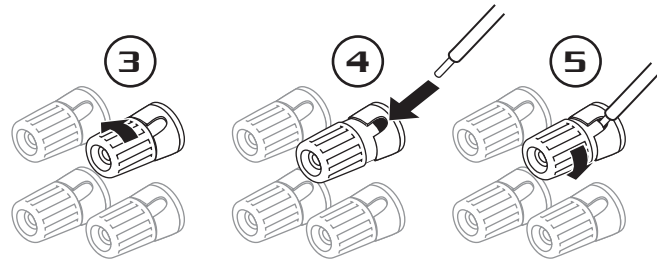

Banana Connector

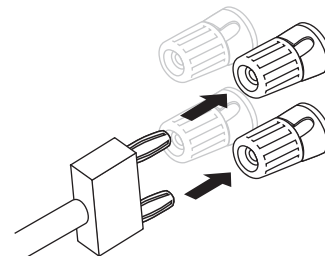

Using Banana Connectors

1. Plug the Banana connectors into the speakers, ensuring the black and red connectors are aligned properly.
2. Plug the other ends of the cables into the KR-3808 PRO's speaker output, ensuring the black and red connectors are aligned properly.

Getting Connected cont.

Connecting to the KR-3808 PRO's Inputs

There are three available A/V input channels which allow you to connect up to three A/V players to the KR-3808 PRO: DVD, AV1, and AV2.

Connecting a DVD, CD or other A/V Player with RCA Audio and Video Outputs to the DVD Input

A DVD, CD or other A/V player can be connected to the DVD input using the L/R (red & white) RCA audio inputs and the RCA video (yellow) input.

What you will need

- Player with RCA audio and video outputs
- RCA L/R audio cable (red & white)
- RCA video cable (yellow)

Audio

1. Connect one end of the red and white RCA audio cable to the L/R audio outputs on your player.
2. Connect the other end of the red and white RCA audio cable to the DVD L/R audio inputs on the KR-3808 PRO rear panel.

Video

1. Connect one end of the RCA video cable to the RCA video output on your player.
2. Connect the other end of the RCA video cable to one of the RCA video inputs on the KR-3808 PRO's rear panel.
3. Select the proper input channel on the KR-3808 PRO.

NOTE: All three of the A/V input channels have RCA audio and video inputs so make sure the correct one is selected.

Selecting the Correct input channel

Front panel: Press the INPUT button on the KR-3808 PRO front panel until the DVD is illuminated in the display window.

Remote Control: Press the input button on the remote control until the DVD is illuminated in the display window.

KR-3808 PRO rear panel

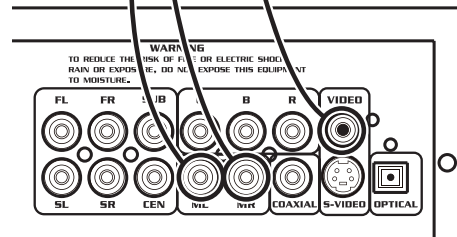
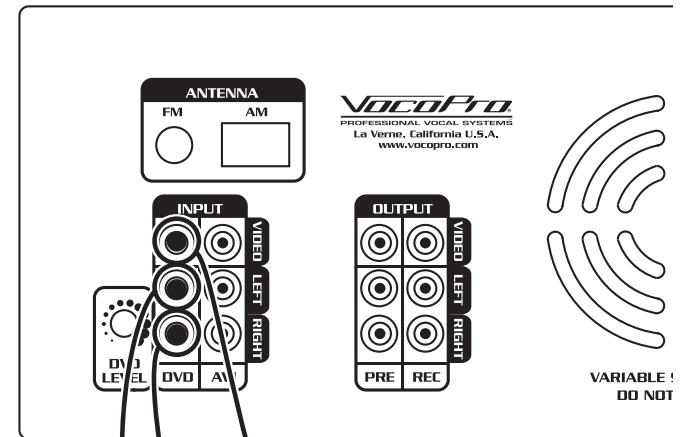

DVD player
DVG-888K shown

Getting Connected cont.

Connecting a CD+G Player with RCA Audio and Video Outputs to the CD Input

A CD+G player can be connected to the AV1 inputs using the L/R (red & white) RCA audio inputs and the RCA video (yellow) input.

What you will need

- Player with RCA audio and video outputs
- RCA L/R audio cable (red & white)
- RCA video cable (yellow)

Audio

1. Connect one end of the red and white RCA audio cable to the L/R audio outputs on your player.
2. Connect the other end of the red and white RCA audio cable to the AV1 L/R audio inputs on the KR-3808 PRO rear panel.

Video

1. Connect one end of the RCA video cable to the RCA video output on your player.
2. Connect the other end of the RCA video cable to the AV1 RCA video inputs on the KR-3808 PRO's rear panel.
3. Select the proper input channel on the KR-3808 PRO.

NOTE: All three of the A/V input channels have RCA audio and video inputs so make sure the correct one is selected.

Selecting the Correct input channel

Front panel: Press the INPUT button on the KR-3808 PRO front panel until AV1 is illuminated in the display window.

Remote Control: Press the input button on the remote control until AV1 illuminated in the display window.

KR-3808 PRO rear panel

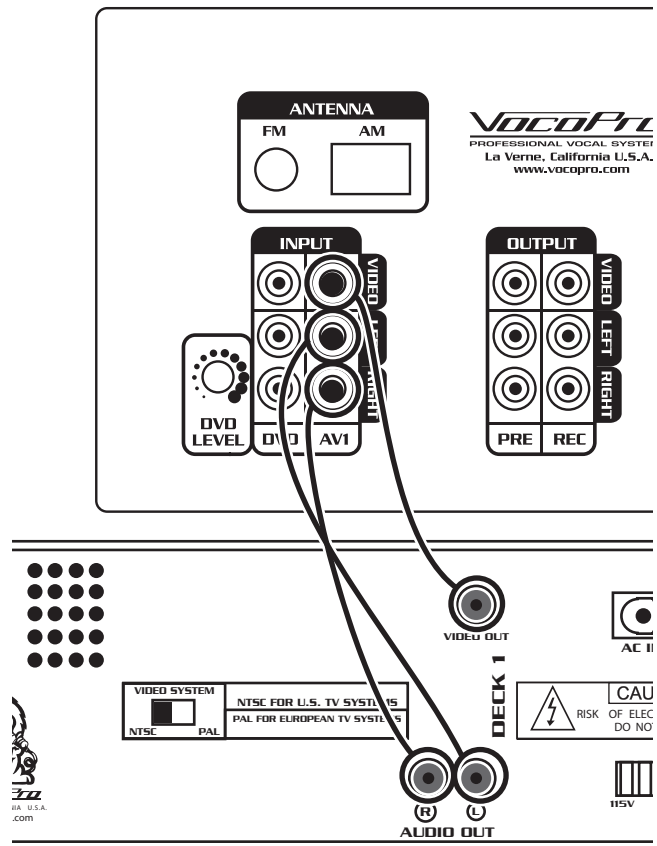

CD+G player
CDG-9000 PRO shown

Getting Connected cont.

Connecting a Player with RCA Audio and Video Outputs to the AV2 Input or Mp3 Player to the 1/8" input

A DVD, CD or other A/V player can be connected to the AV2 inputs using the L/R (red & white) RCA audio inputs and the RCA video (yellow) input, or the 1/8" input can be used to connect an Mp3 player or laptop.

What you will need to connect to the AV2 RCA input

- Player with RCA audio and video outputs
- RCA AV cable (red, white and yellow)

Audio

1. Connect one end of the red and white RCA audio cable to the L/R audio outputs on your player.
2. Connect the other end of the red and white RCA audio cable to the AUX L/R audio inputs on the KR-3808 PRO rear panel.

Video

1. Connect one end of the RCA video cable to the RCA video output on your player.
2. Connect the other end of the RCA video cable to the AUX RCA video inputs on the KR-3808 PRO's rear panel.
3. Select the proper input channel on the KR-3808 PRO.

What you will need to connect to the AV2 1/8" input

- Mp3 Player, Laptop, or Player with 1/8" audio output
- 1/8" cable

Audio

1. Connect one end of the 1/8" cable to the output on your player.
2. Connect the other end of the 1/8" cable to the 1/8" input the KR-3808 PRO front panel.

Selecting the Correct input channel

Front panel: Press the INPUT button on the KR-3808 PRO front panel until AV2 is illuminated in the display window.

Remote Control: Press the input button on the remote control until AV2 is illuminated in the display window.

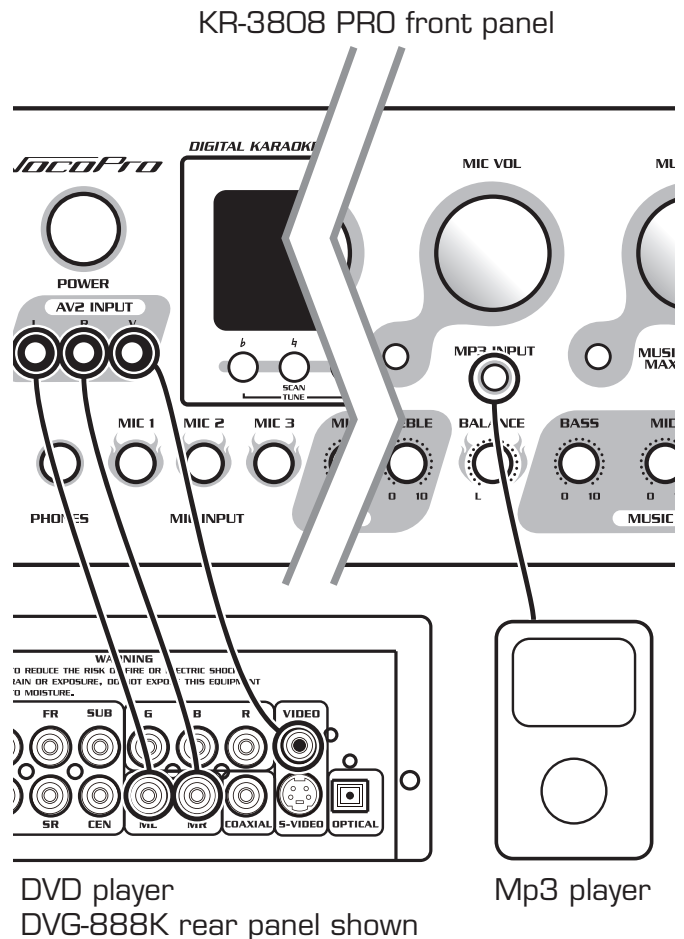

Getting Connected cont.

Connecting to the REC OUT or LINE OUT jacks

The L/R (red and white) RCA Record Output or PRE (Line Level) Output jacks on the rear panel can be connected to any self-powered input device with RCA inputs (i.e. recording device, powered speakers, etc).

What you will need:

- Powered device with L/R RCA inputs
- RCA L/R audio cable (red & white)

1. Connect one end of the red and white RCA cable to the REC OUT jacks on the KR-3808 PRO's rear panel.
2. Connect the other end of the red and white RCA cable to the RCA inputs on the recording device, powered speakers, etc.

KR-3808 PRO rear panel

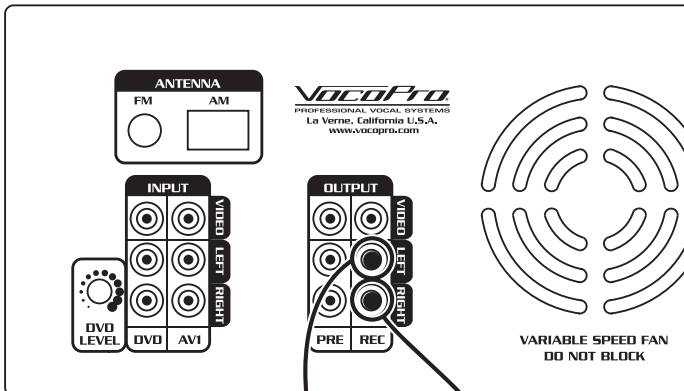

Recorder
CDR-1000 PRO shown

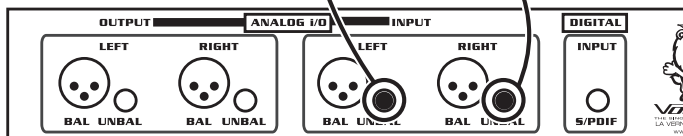

KR-3808 PRO rear panel

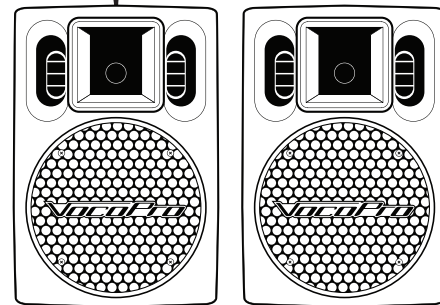
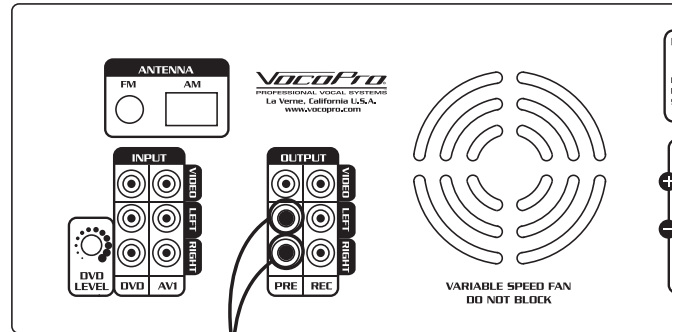

Powered Speakers
PV-802 shown

Getting Connected cont.

Connecting to a TV using the RCA Video (yellow) Output

What you will need

- TV/ video monitor with an RCA video input
- RCA video cable (yellow)

1. Connect one end of the RCA video cable to either of the two RCA video OUT jack on the KR-3808 PRO rear panel.
2. Connect the other end of the RCA video cable to the RCA video input on the TV/Video monitor.
3. Make sure the TV/Video monitor is set to the correct video input. Consult the TV/Video monitor's user manual for the necessary instructions.

KR-3808 PRO rear panel

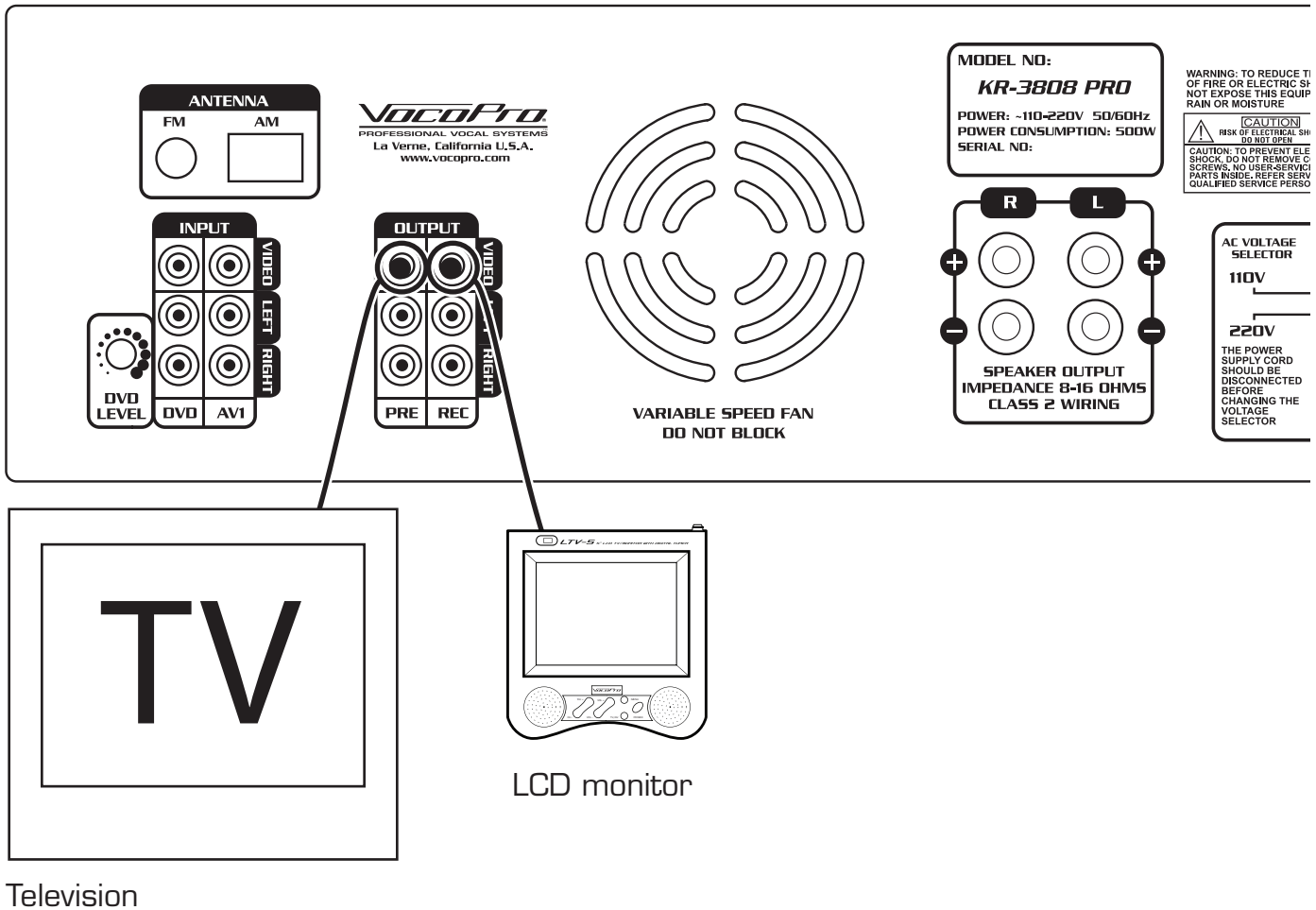

Front Panel Descriptions and Functions

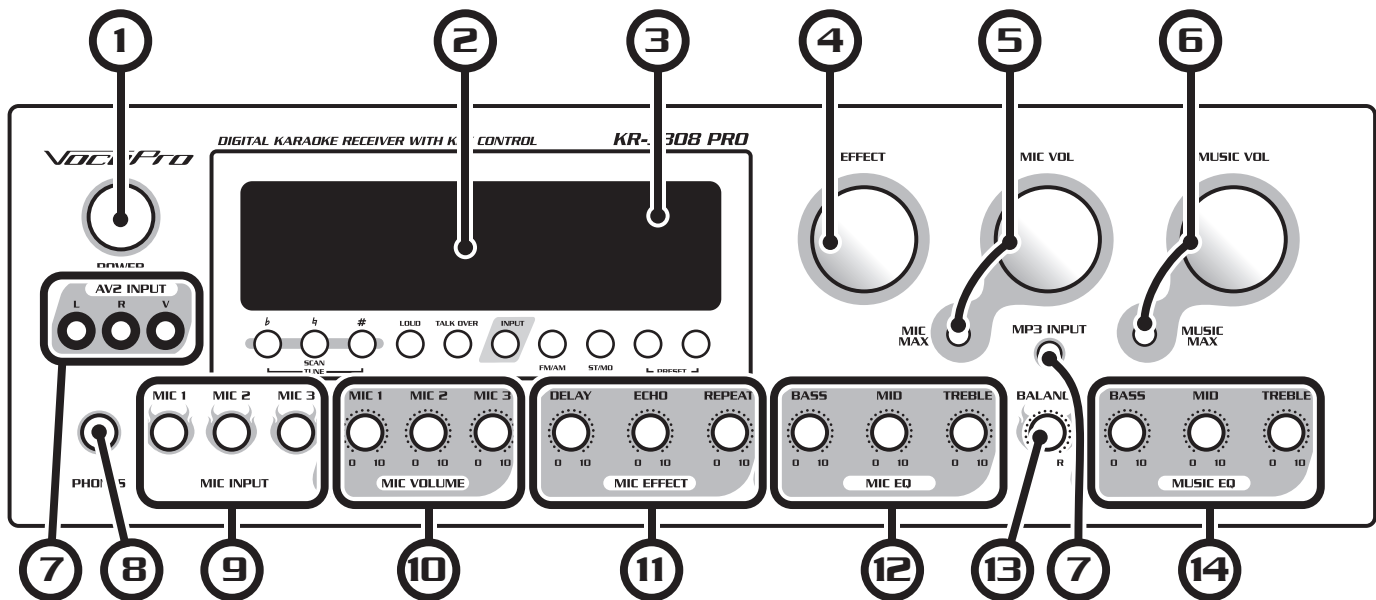

1. **POWER** - Use this button to turn the KR-3808 PRO ON or OFF.
2. **DISPLAY** - Displays setting information.
3. **REMOTE SENSOR** - When operating the KR-3808 PRO with the REMOTE CONTROL, direct the REMOTE towards this SENSOR within 23 feet. Maintain a line of sight between REMOTE and REMOTE SENSOR clear of obstacles to prevent signal blockage.
4. **EFFECT** - This controls the overall level for the effects on all three MIC INPUTS. Rotate clockwise to increase the amount of effect applied to the signal, and counter-clockwise to decrease.
5. **MIC VOLUME** - This control adjusts the output level for MIC 1, 2 and 3. Turn clockwise to increase output and counter-clockwise to decrease. **MIC MAX** - This control adjusts the maximum output level of the MIC VOLUME control. Turn clockwise to increase the maximum level, counter-clockwise to decrease. Adjust with a flat-head screwdriver.
6. **MUSIC VOLUME** - This control adjusts the output level for which-ever player connected to an AUDIO INPUT and assigned with the INPUT selector. Turn clockwise to increase output and counter-clockwise to decrease. **MUSIC MAX** - This control adjusts the maximum output level of the MUSIC VOLUME control. Turn clockwise to increase the maximum level, counter-clockwise to decrease. Adjust with a flat-head screwdriver.
7. **AV2/Mp3 INPUT** - Connect an AV device to the RCA jacks or Mp3 player to the 1/8" jack.
8. **HEADPHONE JACK** - Connect your 1/4" cabled headphones to this output.
9. **MIC 1, 2, 3 INPUTS** - Connect your 1/4" cabled microphones into any of these three inputs.

Front Panel Descriptions and Functions cont.

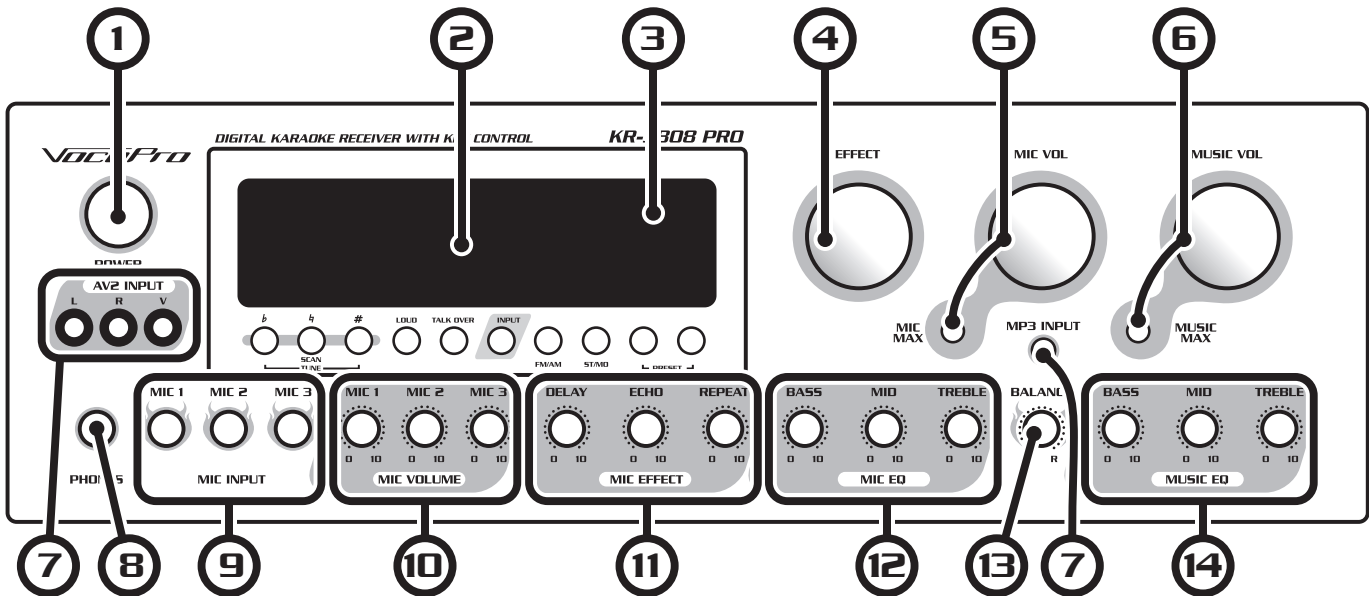

10. MICROPHONE VOLUME CONTROLS - These level controls for MIC 1, 2 and 3 should be adjusted individually to get the best mix when multiple performers are singing. Rotate clockwise to increase and counter-clockwise to decrease VOLUME for each mic.

11. MIC EFFECT

DELAY - This control adjusts the length of time for each ECHO interval, or REPEAT. Rotating the DELAY control clockwise will increase the DELAY, creating the effect of more "space."

ECHO - This control adjusts the level of echo. Rotate clockwise to increase the level of echo and counter-clockwise to decrease.

REPEAT - This control adjusts the number of ECHO repeats applied to the signal until the effect decays, or fades out.

12. MIC EQ

BASS - This control adjusts the low end frequency level of your MIC INPUT.

MIDDLE - This control adjusts the mid-range frequency level of your MIC INPUT.

TREBLE - This control adjusts the high end frequency level of your MIC INPUT.

13. BALANCE - This control adjusts the balance of the output to the left or right channel.

14. MUSIC EQ

BASS - This control adjusts the low end frequency level of your MUSIC source.

MIDDLE - This control adjusts the mid-range frequency level of your MUSIC source.

TREBLE - This control adjusts the high end frequency level of your MUSIC source.

Front Panel Descriptions and Functions cont.

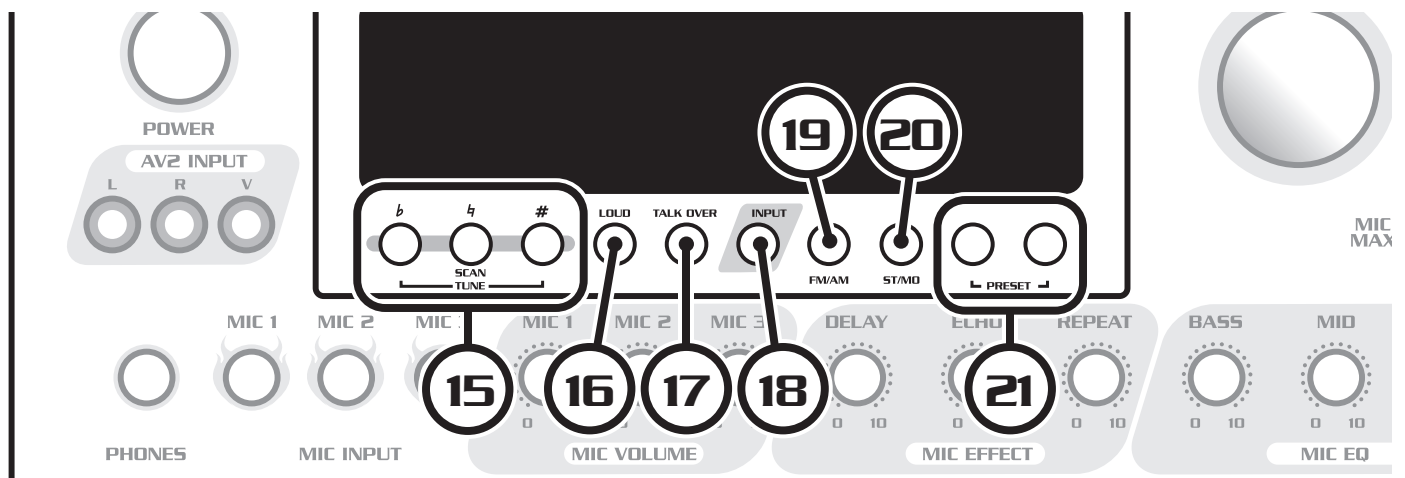

15. DIGITAL KEY CONTROL/SCAN AND TUNE - While the input is set to DVD, AV1 or AV2 these buttons will adjust the key of your source music in half-step increments to match the natural range of your voice using these buttons.

b Flat - lower the key.

Sharp - raise the key.

4 Natural - return to the original key of the music input source.

You will see the DISPLAY reflect the KEY CONTROL step you have selected. The increase in numbers for both flat (*b*) and sharp (*#*) represent an increase in amount of key change from the original or natural, 1 being the least amount, 4 being the most.

SCAN AND TUNE - When the input is set to TUNER, these buttons will scan and tune radio stations. Use the tune buttons to change the radio frequency up or down. Use the scan button to automatically find the next strong radio station. See the operations section of this manual for details about setting radio station presets.

16. LOUD (LOUDNESS CONTROL) - For an instant music Volume/Gain, the LOUD button is an easy way to improve your mix when you need an extra boost. Perfect for varying volume controls between tracks or singers.

17. TALK OVER - Turning this setting on will instantly reduce the volume of the the music while any MIC on any of the three MIC INPUTS are in, spoken or sung into. The volume will gradually fade-in once the microphone is no longer in use.

18. INPUT - This button allows you to select between DVD, AV1 and AV2 input to the KR-3808 PRO. This allows the KR-3808 PRO to differentiate between all the related source AUDIO INPUT options available on the back panel. If the button is held for approximately one second, the AUTO setting will be selected and highlighted on the display. This mode will have the KR-3808 PRO automatically switch to the DVD input when the signal from AV1 or AV2 is stopped. Note: The switch to DVD when the signal stops may take a few seconds.

19. FM/AM - This button switches between AM and FM radio when the tuner is selected.

20. ST/MO - This button switches between stereo and mono while using the tuner set to FM.

21. PRESET CHANNEL +/- - These buttons change the radio station preset channel. Preset + will switch to the next preset channel and preset - will switch to the previous preset channel. See the operations section of this manual for details about setting radio station presets.

Rear Panel Descriptions and Functions

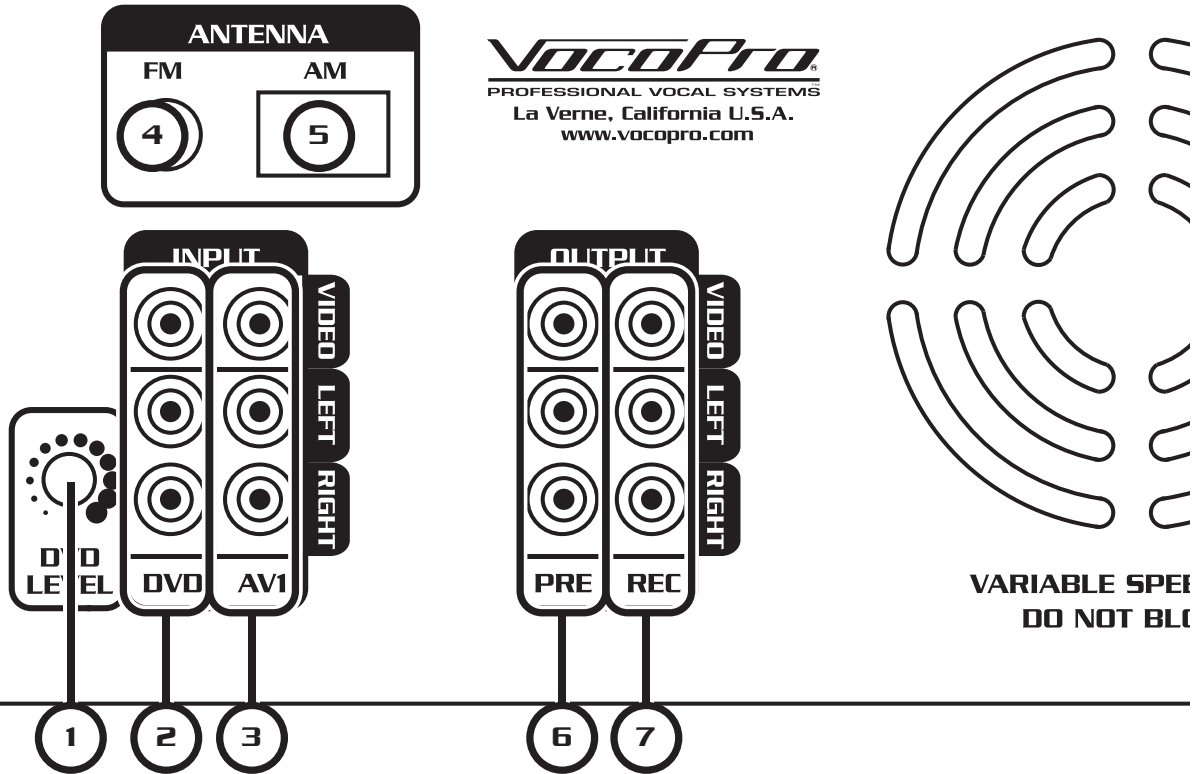

1. **DVD VOLUME CONTROL** - This controls the output level of the DVD source. Turn clockwise to increase output, counter-clockwise to decrease.
2. **DVD RCA INPUT** - RCA audio/video input for the DVD input channel. Connect here using a standard white/red/yellow RCA cable.
3. **AV1 RCA INPUT** - RCA audio/video input for the AV1 input channel. Connect here using a standard white/red/yellow RCA cable.
4. **FM ANTENNA INPUT** - FM ANTENNA input. Connect the FM antenna to this jack for FM radio reception.
5. **AM ANTENNA INPUT** - AM ANTENNA loop. Connect the AM antenna to the jack for AM radio reception.
6. **PRE (Line Level) RCA OUTPUT** - Connect a standard white/red/yellow RCA cable from this output to the video input of your TV or other video monitor device and to powered speakers or any device with RCA inputs.
7. **RECORD RCA OUTPUT** - These RCA output jacks are designated for connection to a recording device such as a cassette deck, CD burner or hard drive recorder.

Rear Panel Descriptions and Functions cont.

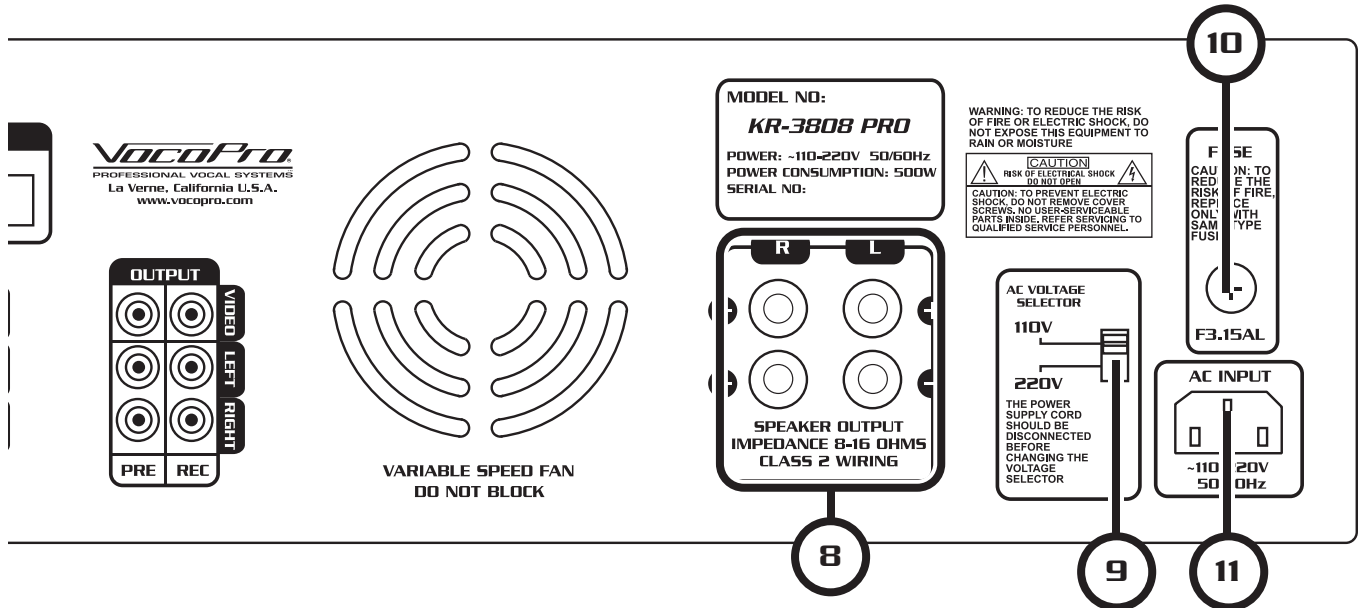

8. **SPEAKER OUTPUT** - You can connect two different speakers between SPEAKERS OUTPUT L and R. Exposed speaker wire can be used by removing the corresponding left or right knob from the speaker terminal by turning counter-clockwise, inserting the wire and re-inserting the knob and securing it by tightening clockwise. "Banana plug" style speaker cables can also be used for left and right of each pair. Refer to the "Getting Connected" portion of this manual for further information on connecting your speakers and the use of "banana plug" connections.
9. **VOLTAGE SELECTOR** - Using this switch you can select between 110V and 220V power settings.
NOTE: The power supply cord should be disconnected before changing the voltage selector.
10. **FUSE** - This plastic cover is the housing for the KR-3808 PRO's fuse. Use only the type marked on the rear panel when replacing the fuse.
11. **AC INPUT** - Connect the power cable here.

Remote Control Descriptions and Functions

The maximum operating distance between the Remote Control and the REMOTE SENSOR is approximately 23 feet. If the effective distance of the Remote decreases, replace the batteries. To install new batteries, remove the battery compartment lid on the back of the Remote and insert two AA batteries with polarities aligned.

1. **INPUT** - This button allows you to select between DVD, AV1, AV2, and TUNER inputs.
2. **TALK OVER** - Turning this setting on will instantly reduce the volume of the the music while any MIC on any of the three MIC INPUTS are in, spoken or sung into. The volume will gradually fade-in once the microphone is no longer in use.
3. **LOUD (LOUDNESS CONTROL)** - For an instant music Volume/Gain, the LOUDNESS button is an easy way to improve your mix when you need an extra boost. Perfect for varying volume controls between tracks or singers.
4. **NUMBER PAD** - Use these buttons to access preset radio stations. See the operations section for details about setting the radio station presets.
5. **SCAN** - Use this button to automatically find the next strong radio station.
6. **FM/AM** - Use these buttons to switch between AM and FM.
7. **MEMORY** - Use this button to set the radio station preset. See the operations section for details about setting the radio station presets.
8. **ST/MO** - Use these buttons to switch between stereo and mono while using the tuner set to FM.
9. **DIGITAL KEY CONTROL/TUNE+-** - Adjust the key of your source music in half-step increments to fit the natural range of your voice using these buttons.
 - b* Flat - lower the key.
 - #* Sharp - raise the key.
 - 4* Natural - return to the original key of the music input source.
 You will see the DISPLAY reflect the KEY CONTROL step you have selected. The increase in numbers for both flat *b* and sharp *#* represent an increase in amount of key change from the original or natural, 1 being the least amount, 4 being the most.

TUNE+- - While in TUNER mode use the + and - buttons to change the radio station.
10. **CH+/CH-** - Use these buttons to change between the radio station preset channels. CH+ will go to the next preset, and CH- will go to the previous preset. See the operations section for details about setting the radio station presets.
11. **EFFECT** - This control is the overall level of effect on all three MIC INPUTS. Use the up (▲) button to increase the effect and the down (▼) button to reduce the effect.
12. **MIC VOLUME** - Use the up (▲) button to raise the MIC MASTER VOLUME and the down (▼) button to lower this mixed MIC MASTER VOLUME.
13. **MUSIC VOLUME** - Use the up (▲) button to raise the MUSIC VOLUME and the down (▼) button to lower the MUSIC VOLUME.

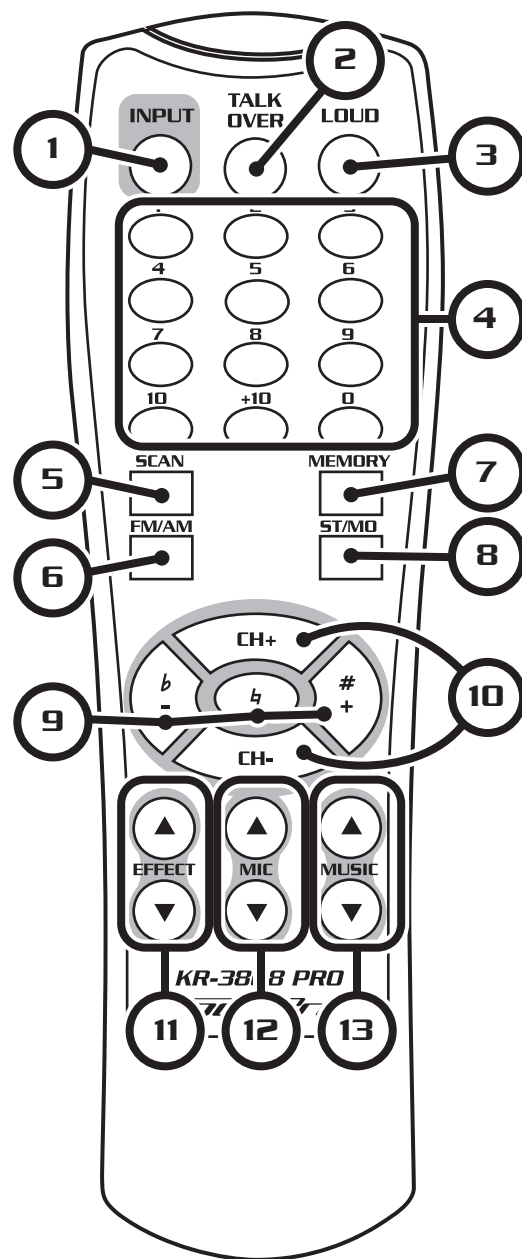

Operations

Setting the Radio Station Presets

There are 60 programmable radio station presets available on the KR-3808 PRO (30 for AM and 30 for FM).

To set a radio station preset.

1. Use the PRESET CHANNEL + and - (CH+ and CH- on remote control) to select a preset number, ie CH4.
2. Use the SCAN or TUNE buttons to select the radio station you would like to assign to the preset.
3. Press and hold the SCAN button on the front panel (memory on remote control) to assign the current radio station to CH4.
4. Repeat the previous steps for addition presets.

Using the AUTO Feature

The AUTO feature is designed to conveniently switch between active input channels and eliminate moments of silence between Karaoke performances. When playback is initiated on a player connected to the AV1 or AV2 channels, the KR-3808 automatically selects that channel as the active input channel. When there is no signal detected from the AV1 or AV2 channels, the KR-3808 automatically switches to the DVD channel.

To utilize the DVD channel, simply connect a source player to the DVD jacks and have it set to repeat playback or similar playback mode with a steady stream of music/video output. When playback ends on a player connected to the AV1 or AV2 channels, DVD channel playback will immediately begin eliminating extended periods of silence between performances.

To adjust the level of the DVD audio, use the DVD LEVEL dial on the back panel, located near the DVD input.

To enable the AUTO feature, press and hold the INPUT button down until the AUTO indicator is illuminated.

To disable the AUTO feature, press the INPUT button to return to manual input selection.

Note: The switch to DVD when the signal stops may take a few seconds.

Using the TALK OVER Feature

The talk over function can be useful for making announcements without having to manually adjust the master volume. With the talk over function active, the music volume will be reduced automatically when the microphones are spoken into. For Karaoke, it's recommended that you leave the talk over function off.

To enable the talk over function, press the TALK button on the front panel or remote control. The TALK light will illuminate in the display window.

To turn off the talk over function, press the TALK button on the front panel or remote control. The TALK light will turn off in the display window.

Troubleshooting

No sound output.	<ul style="list-style-type: none">• Make sure the KR-3808 PRO is set to the correct input.• Make sure the volume is turned up.• Make sure everything is connected firmly and properly.• Make sure there are no defective cables.• Make sure all of your components are turned on.
No sound output when DVD source is playing.	<ul style="list-style-type: none">• Make sure the KR-3808 PRO is set to the DVD input.• Make sure the rear DVD volume is turned up.
There is music but no microphone vocals.	<ul style="list-style-type: none">• Make sure the microphone is turned on.• Make sure the microphone cable is not disconnected or damaged.• Make sure the microphone master volume or individual microphone volume controls are turned up to the proper level.
The remote control is not working.	<ul style="list-style-type: none">• The KR-3808 PRO power is not on. Make sure the main power switch is on.• Make sure the batteries are inserted correctly and not out of power.• Make sure there is nothing blocking the view between the remote control and the remote sensor on the front of the KR-3808 PRO.

VocoPro®

PROFESSIONAL VOCAL SYSTEMS™

