

# VocoPro<sup>®</sup>

PROFESSIONAL VOCAL SYSTEMS<sup>™</sup>

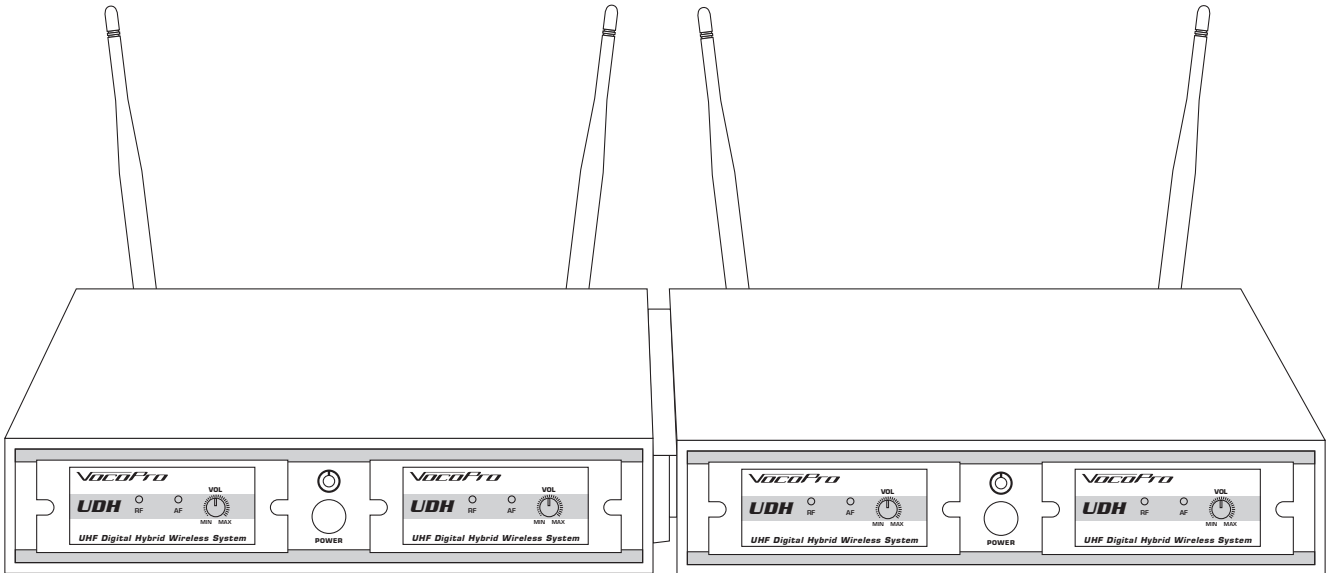

## ***UDH-Ultra***

***UHF/DSP Hybrid Wireless Microphone System***

o w n e r ' s m a n u a l



# Table of Contents

Safety Instructions . . . . .	4
FCC Information . . . . .	5
Welcome. . . . .	6
Listening for a Lifetime . . . . .	7
Getting Started . . . . .	8
Descriptions and Functions . . . . .	10
Getting Connected . . . . .	13
Commonly Asked Questions . . . . .	15

## SPECIFICATIONS

- Dual Balanced XLR Outputs per Receiver
- Mixed Unbalanced 1/4" Output per Receiver
- Individual Mic Channel Volume Control
- Digitally Optimized DSP
- Rack Mounted Locking Rails
- Utilizes the sparsely used 900 MHz Frequency Band
- 1 Year Warranty

# Safety Instructions



## CAUTION RISK OF SHOCK



CAUTION: To reduce the risk of electric shock, do not remove cover (or back). No user-serviceable parts inside. Only refer servicing to qualified service personnel.

### Explanation of Graphical Symbols



The lightning flash & arrowhead symbol, within an equilateral triangle, is intended to alert you to the presence of danger.



The exclamation point within an equilateral triangle is intended to alert you to the presence of important operating and servicing instructions.

### WARNING

To reduce the risk of fire or electric shock, do not expose this unit to rain or moisture.

- 1. Read Instructions** - All the safety and operating instructions should be read before the appliance is operated.
- 2. Retain Instructions** - The safety and operating instructions should be retained for future reference.
- 3. Heed Warnings** - All warnings on the appliance and in the operating instructions should be adhered to.
- 4. Follow Instructions** - All operating and use instructions should be followed.
- 5. Attachments** - Do not use attachments not recommended by the product manufacturer as they may cause hazards.
- 6. Water and Moisture** - Do not use this unit near water. For example, near a bathtub or in a wet basement and the like.
- 7. Carts and Stands** - The appliance should be used only with a cart or stand that is recommended by the manufacturer.
- 7 A.** An appliance and cart combination should be moved with care. Quick stops, excessive force, and uneven surfaces may cause an overturn.



- 8. Ventilation** - The appliance should be situated so its location does not interfere with its proper ventilation. For example, the appliance should not be situated on a bed, sofa, rug, or similar surface that may block the ventilation slots.
- 9. Heat** - The appliance should be situated away from heat sources such as radiators, heat registers, stoves, or other appliances (including amplifiers) that produce heat.
- 10. Power Sources** - The appliance should be connected to a power supply only of the type described in the operating instructions or as marked on the appliance.
- 11. Grounding or Polarization** - Precautions should be taken so that the grounding or polarization means of an appliance is not defeated.
- 12. Power-Cord Protection** - Power-supply cords should be routed so that they are not likely to be walked on or pinched by items placed upon or against them, paying particular attention to cords at plugs, convenience receptacles, and the point where they exit from the appliance.
- 13. Cleaning** - Unplug this unit from the wall outlet before cleaning. Do not use liquid cleaners or aerosol cleaners. Use a damp cloth for cleaning.
- 14. Power lines** - An outdoor antenna should be located away from power lines.
- 15. Nonuse Periods** - The power cord of the appliance should be unplugged from the outlet when left unused for a long period of time.
- 16. Object and Liquid Entry** - Care should be taken so that objects do not fall and liquids are not spilled into the enclosure through openings.
- 17. Damage Requiring Service** - The appliance should be serviced by qualified service personnel when:
  - A. The power supply cord or plug has been damaged; or
  - B. Objects have fallen into the appliance; or
  - C. The appliance has been exposed to rain; or
  - D. The appliance does not appear to operate normally or exhibits a marked change in performance; or
  - E. The appliance has been dropped, or the enclosure damaged.
- 18. Servicing** - The user should not attempt to service the appliance beyond that described in the operating instructions. All other servicing should be referred to qualified service personnel.

#### Note:

To CATV system installer's (U.S.A.): This reminder is provided to call the CATV system installer's attention to Article 820-40 of the NEC that provides guidelines for proper grounding and, in particular, specifies that the cable ground shall be connected as close to the point of cable entry as practical.

# FCC Information

## 1. IMPORTANT NOTICE: DO NOT MODIFY THIS

**UNIT!:** This product, when installed as indicated in the instructions contained in this manual, meets FCC requirements. Modifications not expressly approved by Vocopro may void your authority, granted by the FCC, to use this product.

**2. IMPORTANT:** When connecting this product to accessories and/or another product use only high quality shielded cables. Cable(s) supplied with this product **MUST** be used. Follow all installation instructions. Failure to follow instructions could void your FCC authorization to use this product in the U.S.A.

**3. NOTE:** This product has been tested and found to comply with the requirements listed in FCC Regulations, Part 15 for Class "B" digital devices. Compliance with these requirements provides a reasonable level of assurances that your use of this product in a residential environment will not result in harmful interference with other electronic devices. This equipment generates/uses radio frequencies and, if not installed and used according to the instructions found in the owner's manual, may cause interference harmful to the operation of other electronic devices. Compliance with FCC regulations does not guarantee that interference will not occur in all installations. If this product is found to be the source of interference, which can be determined by turning the unit "Off" and "On", please try to eliminate the problem by using one of the following measures:

Relocate either this product or the device that is being affected by the interference.

Use power outlets that are on different branch (circuit breaker or fuse) circuits or install AC line filter(s).

In the case of radio or TV interference, relocate/reorient the antenna. If the antenna lead-in is 300-ohm ribbon lead, change the lead-in to coaxial type cable.

If these corrective measures do not produce satisfactory results, please contact your local retailer authorized to distribute Vocopro products. If you can not locate the appropriate retailer, please contact Vocopro, 1728 Curtiss Court, La Verne, CA 91750.

## CAUTION

The apparatus is not disconnected from the AC power source so long as it is connected to the wall outlet, even if the apparatus itself is turned off. To fully ensure that the apparatus is indeed fully void of residual power, leave unit disconnected from the AC outlet for at least fifteen seconds.

## CALIFORNIA PROP 65 WARNING

**WARNING:** This product contains chemicals known to the state of California to cause cancer and birth defects or other reproductive harm. (California law requires this warning to be given to customers in the State of California.)

For more information: [www.vocopro.com/prop65](http://www.vocopro.com/prop65)

## CAUTION:

### READ THIS BEFORE OPERATING YOUR UNIT

1. To ensure the finest performance, please read this manual carefully. Keep it in a safe place for future reference.
2. Install your unit in a cool, dry, clean place - away from windows, heat sources, and too much vibration, dust, moisture or cold. Avoid sources of hum (transformers, v motors). To prevent fire or electrical shock, do not expose to rain and water.
3. Do not operate the unit upside-down.
4. Never open the cabinet. If a foreign object drops into the set, contact your dealer.
5. Place the unit in a location with adequate air circulation. Do not interfere with its proper ventilation; this will cause the internal temperature to rise and may result in a failure.
6. Do not use force on switches, knobs or cords. When moving the unit, first turn the unit off. Then gently disconnect the power plug and the cords connecting to other equipment. Never pull the cord itself.
7. Do not attempt to clean the unit with chemical solvents: this might damage the finish. Use a clean, dry cloth.
8. Be sure to read the "Troubleshooting" section on common operating errors before concluding that your unit is faulty.
9. This unit consumes a fair amount of power even when the power switch is turned off. We recommend that you unplug the power cord from the wall outlet if the unit is not going to be used for a long time. This will save electricity and help prevent fire hazards. To disconnect the cord, pull it out by grasping the plug. Never pull the cord itself.
10. To prevent lightning damage, pull out the power cord and remove the antenna cable during an electrical storm.
11. The general digital signals may interfere with other equipment such as tuners or receivers. Move the system farther away from such equipment if interference is observed.

## NOTE:

Please check the copyright laws in your country before recording from records, compact discs, radio, etc. Recording of copyrighted material may infringe copyright laws.

## Voltage Selector (General Model Only)

Be sure to position the voltage selector to match the voltage of your local power lines before installing the unit.

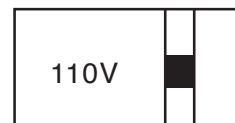



## Welcome

And thank you for purchasing the **UDH-Ultra** from VocoPro, your ultimate choice in Karaoke entertainment! With years of experience in the music entertainment business, VocoPro is a leading manufacturer of Karaoke equipment, and has been providing patrons of bars, churches, schools, clubs and individual consumers the opportunity to sound like a star with full-scale club models, in-home systems and mobile units. All our products offer solid performance and sound reliability, and to reinforce our commitment to customer satisfaction, we have customer service and technical support professionals ready to assist you with your needs. We have provided some contact information for you below.

### VocoPro

1728 Curtiss Court  
La Verne, CA 91750  
**Toll Free: 800-678-5348**  
TEL: 909-593-8893  
FAX: 909-593-8890

#### VocoPro Company Email Directory

##### Customer Service & General Information

info@vocopro.com

##### Tech Support

techsupport@vocopro.com

#### Remember Our Website

Be sure to visit the VocoPro website **www.vocopro.com** for the latest information on new products, packages and promos. And while you're there don't forget to check out our Club VocoPro for Karaoke news and events, chat rooms, club directories and even a KJ Service directory!

We look forward to hearing you sound like a PRO, with VocoPro, the singer's ultimate choice.

### FOR YOUR RECORDS

Please record the model number and serial number below, for easy reference, in case of loss or theft. These numbers are located on the rear panel of the unit. Space is also provided for other relevant information

**Model Number**

**Serial Number**

**Date of Purchase**

**Place of Purchase**

# Listening for a Lifetime

Selecting fine audio equipment such as the unit you've just purchased is only the start of your musical enjoyment. Now it's time to consider how you can maximize the fun and excitement your equipment offers. VocoPro and the Electronic Industries Association's Consumer Electronics Group want you to get the most out of your equipment by playing it at a safe level. One that lets the sound come through loud and clear without annoying blaring or distortion and, most importantly, without affecting your sensitive hearing.

Sound can be deceiving. Over time your hearing "comfort level" adapts to a higher volume of sound. So what sounds "normal" can actually be loud and harmful to your hearing. Guard against this by setting your equipment at a safe level BEFORE your hearing adapts.

To establish a safe level:

- Start your volume control at a low setting.
- Slowly increase the sound until you can hear it comfortably and clearly, and without distortion.

Once you have established a comfortable sound level:

- Set the dial and leave it there.
- Pay attention to the different levels in various recordings.

Taking a minute to do this now will help to prevent hearing damage or loss in the future. After all, we want you listening for a lifetime.

Used wisely, your new sound equipment will provide a lifetime of fun and enjoyment. Since hearing damage from loud noise is often undetectable until it is too late, this manufacturer and the Electronic Industries Association's Consumer Electronics Group recommend you avoid prolonged exposure to excessive noise. This list of sound levels is included for your protection.

## Some common decibel ranges:

Level	Example
<b>30</b>	Quiet library, Soft whispers
<b>40</b>	Living room, Refrigerator, Bedroom away from traffic
<b>50</b>	Light traffic, Normal Conversation
<b>60</b>	Air Conditioner at 20 ft., Sewing machine
<b>70</b>	Vacuum cleaner, Hair dryer, Noisy Restaurant
<b>80</b>	Average city traffic, Garbage disposals, Alarm clock at 2 ft.

## The following noises can be dangerous under constant exposure:

Level	Example
<b>90</b>	Subway, Motorcycle, Truck traffic, Lawn Mower
<b>100</b>	Garbage truck, Chainsaw, Pneumatics drill
<b>120</b>	Rock band concert in front of speakers
<b>140</b>	Gunshot blast, Jet plane
<b>180</b>	Rocket launching pad

-Information courtesy of the Deafness Research Foundation

# Getting Started

## WHAT'S IN THE BOX - UDH-4-ULTRA

- (1) UDH-Ultra Receiver
- (4) UDH Handheld Microphones
- (4) UDH Bodypack Transmitters
- (4) UDH Bodypack Headset Microphones
- (4) Lavalier Microphones
- (4) XLR-to-1/4" Instrument Cables
- (4) Antennas
- (2) Power Adapter
- (2) Rack Ears

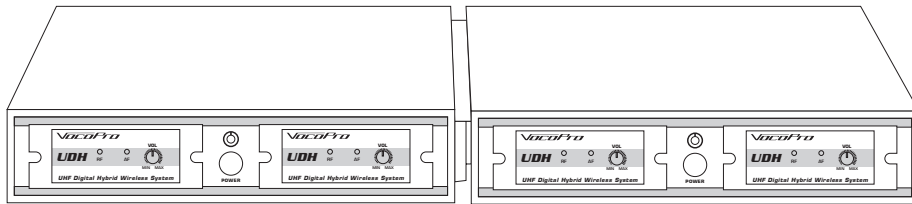

**x1**

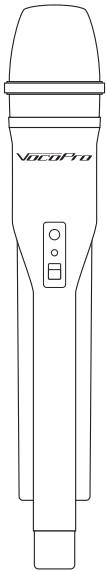

**x4**



**x4**



**x4**

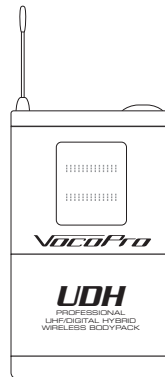

**x4**

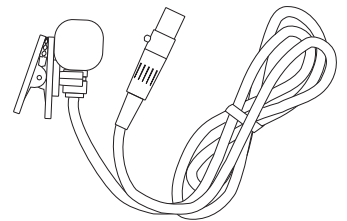

**x4**

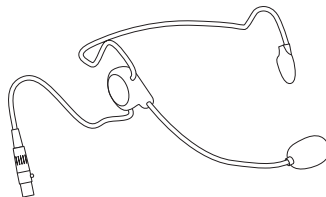

**x4**



**x2**

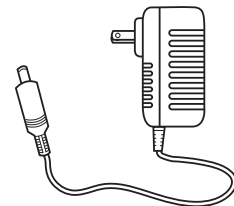

**x2**



# Getting Started

## WHAT'S IN THE BOX - UDH-8-ULTRA

- (2) UDH Receivers
- (8) UDH Handheld Microphones
- (8) UDH Bodypack Transmitters
- (8) UDH Bodypack Headset Microphones
- (8) Lavalier Microphones
- (8) XLR-to-1/4" Instrument Cables
- (8) Antennas
- (4) Power Adapters
- (4) Rack Ears

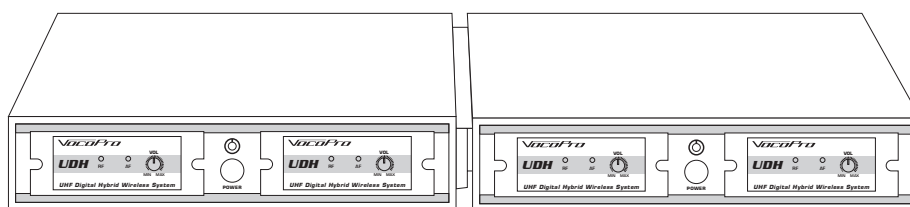

**x2**

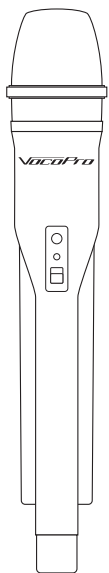

**x8**



**x8**



**x8**

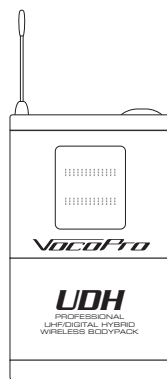

**x8**

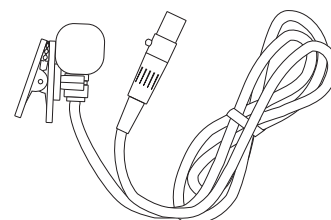

**x8**

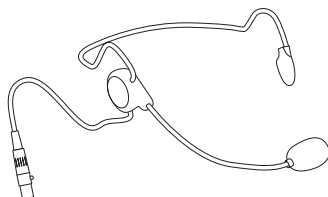

**x8**



**x4**

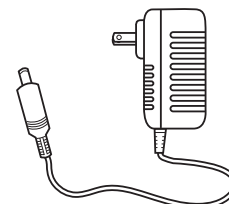

**x4**

# Descriptions and Functions

## RECEIVER

### FRONT PANEL

1. ON/OFF Switch - Powers the receiver off/on.
2. Mic 1 Volume - Adjusts the volume of Mic 1.
3. Mic 2 Volume - Adjusts the volume of Mic 2.
4. RF LEDs - Registers mic status.
5. AF LEDs - Registers mic audio transmission.

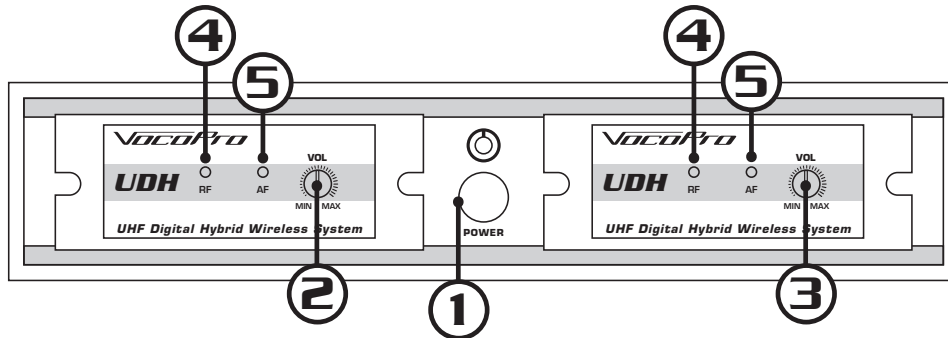

### REAR PANEL

1. BNC Connectors - Used to mount antennas.
2. Unbalanced Mixed Out - Outputs both mic signals via 1/4 cable to a mixer or amplifier.
3. Balanced Mic 1 Out - Outputs Mic 1 via XLR cable to mixer or amplifier.
4. Balanced Mic 2 Out - Outputs Mic 2 via XLR cable to mixer or amplifier.
5. AC Input - Connect AC power adapter here.

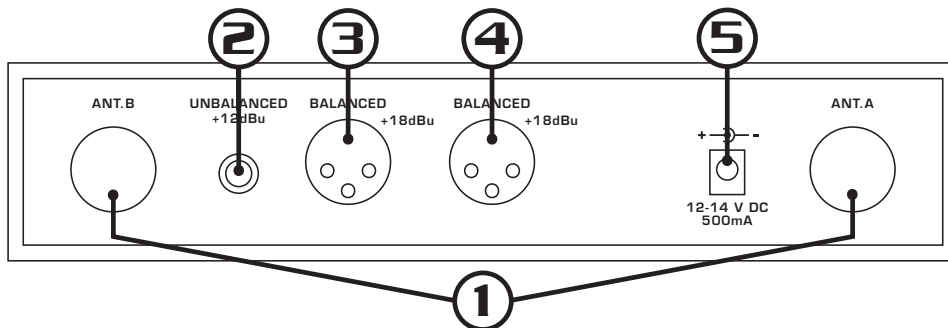

### SIDE PANEL

1. Locking Rails - Used to assemble up to 2 UDH receivers together.

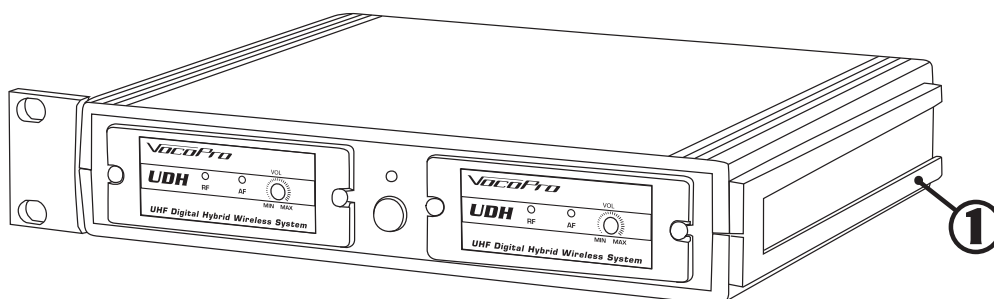

# Descriptions and Functions

## HANDHELD MICROPHONE

1. Mic Head - Picks up vocals

**Note:** Please hold within 6-7 inches of your mouth for best sound.

2. Mic ON/OFF/MUTE Switch - Powers microphone on/off.  
a.) MUTE - Mutes the mic element but leaves microphone powered on.
3. Mic Battery LED - Indicates low battery status.

**Note:** When powered on, the LED will flash once. When battery is low, LED will flash continuously.

4. Battery Compartment - Insert two (2x) AA batteries to provide power.

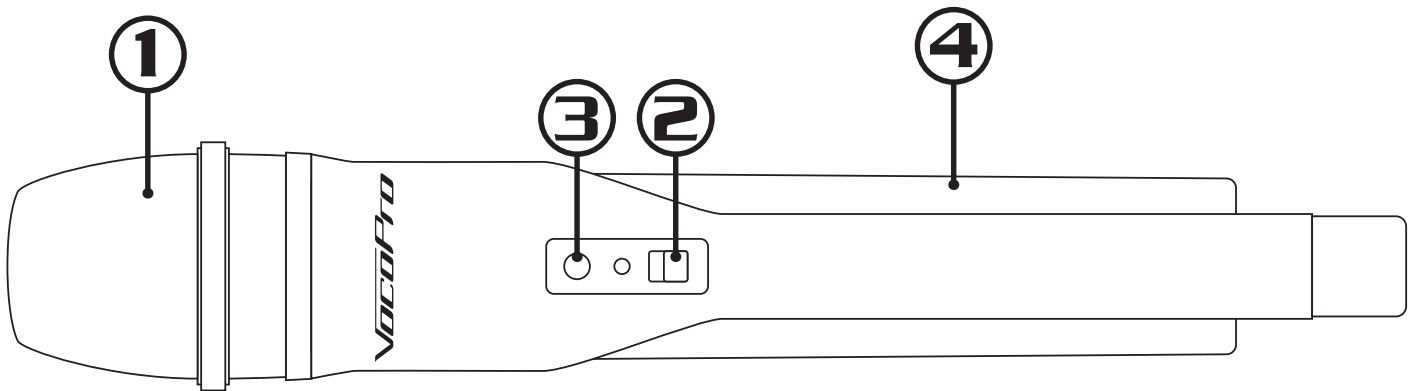

To open the battery compartment, push down here while sliding out.

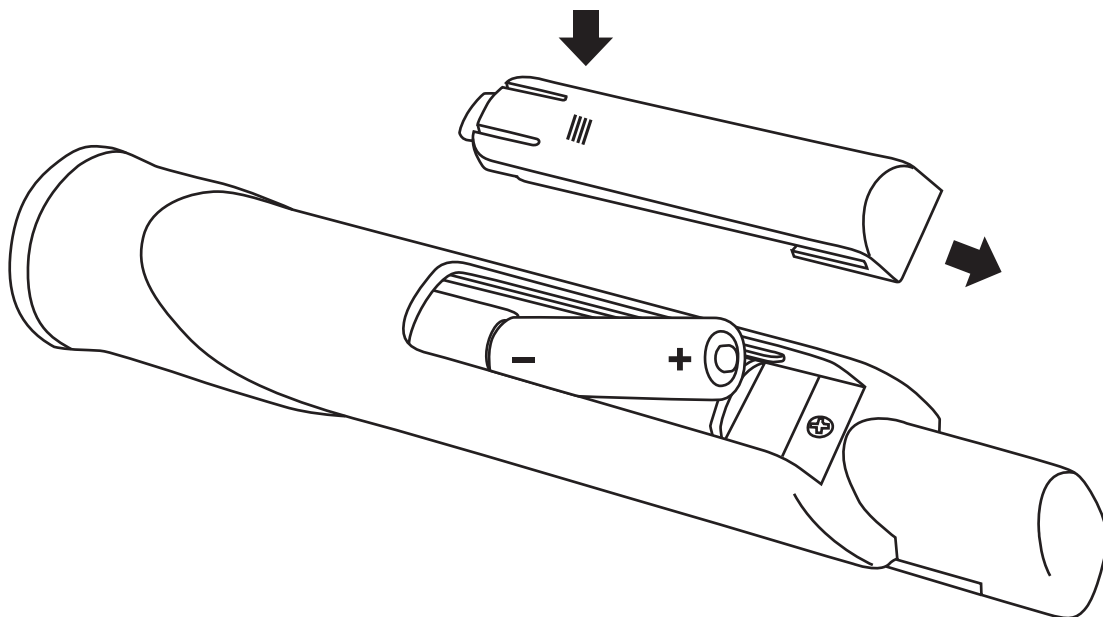

# Descriptions and Functions

## BODYPACK HEADSET MICROPHONES

1. Antenna - Transmits audio to receiver.
2. ON/OFF - Powers bodypack ON/OFF.
3. Power LED - Indicates battery level.
  - a.) Solid Green LED - Battery level is healthy and good to use.
  - b.) Blinking Red LED - Batteries are low and require changing soon.
4. Mini-XLR Jack - Connect headset and lavalier microphone cables here.
5. Gain - Used to alter the overall volume output of the bodypack.

*Note: Gain alters volume output of bodypack only; it is in addition to the volume knob located on the receiver.*

6. Battery Compartment - Insert two (2) AA batteries.

*Note: Rechargeable batteries are ok to use with this bodypack. Ensure rechargeable batteries are recharged in their appropriate charger to avoid damage to the bodypack.*

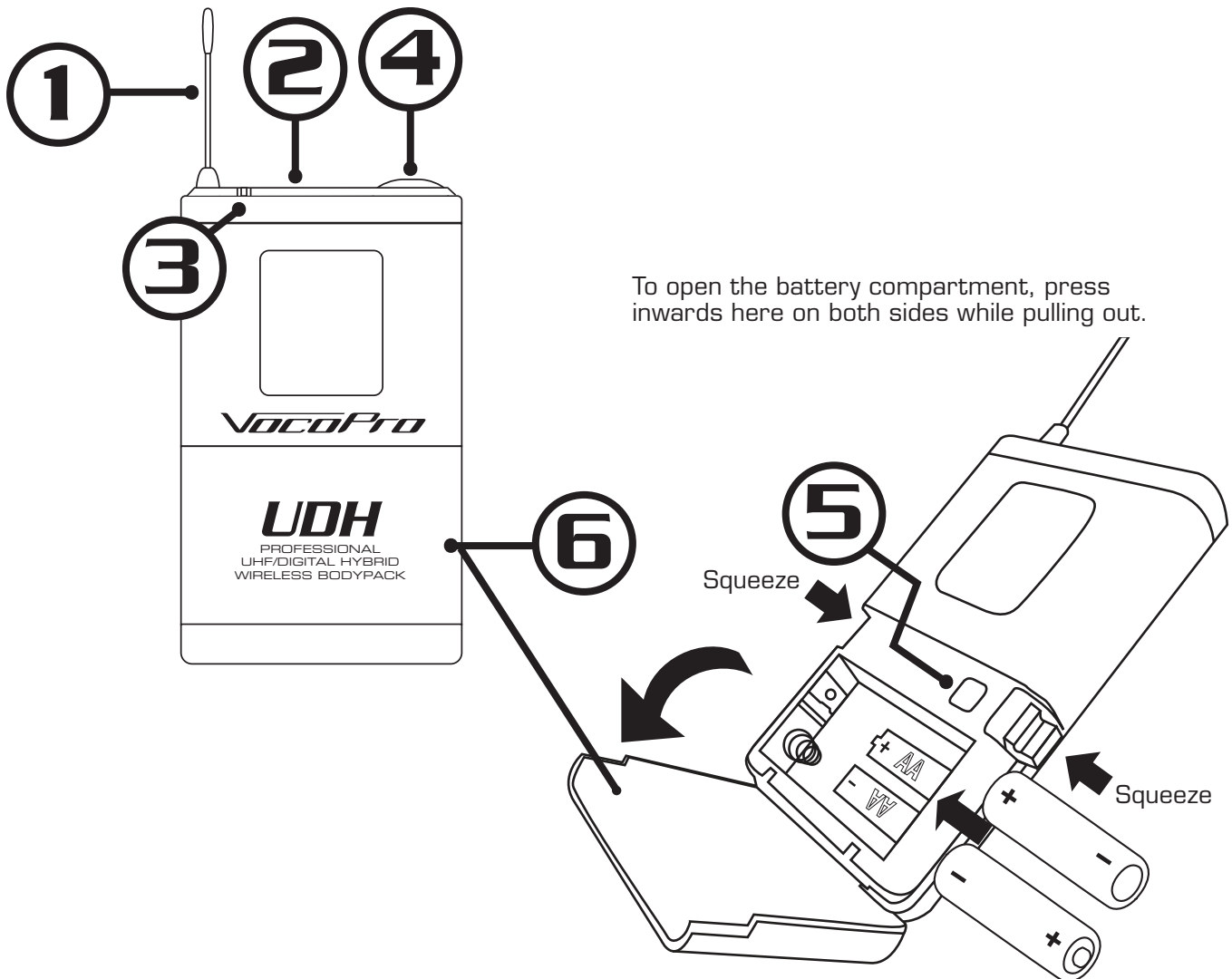

# Getting Connected

## TO CONNECT TO A MIXER

### BALANCED XLR

1. Connect 2 balanced XLR cables (not included) to the balanced outputs of the UDH receiver.
2. Connect each end of the XLR cables into individual microphone input jacks on a mixer to be used (ex. Mic1, Mic 2).

*Note: Example illustrated is for clarity only. For ease of operation, attach the channel 1 output to the channel 1 input on a mixer and the channel 2 output to the channel 2 input on a mixer.*

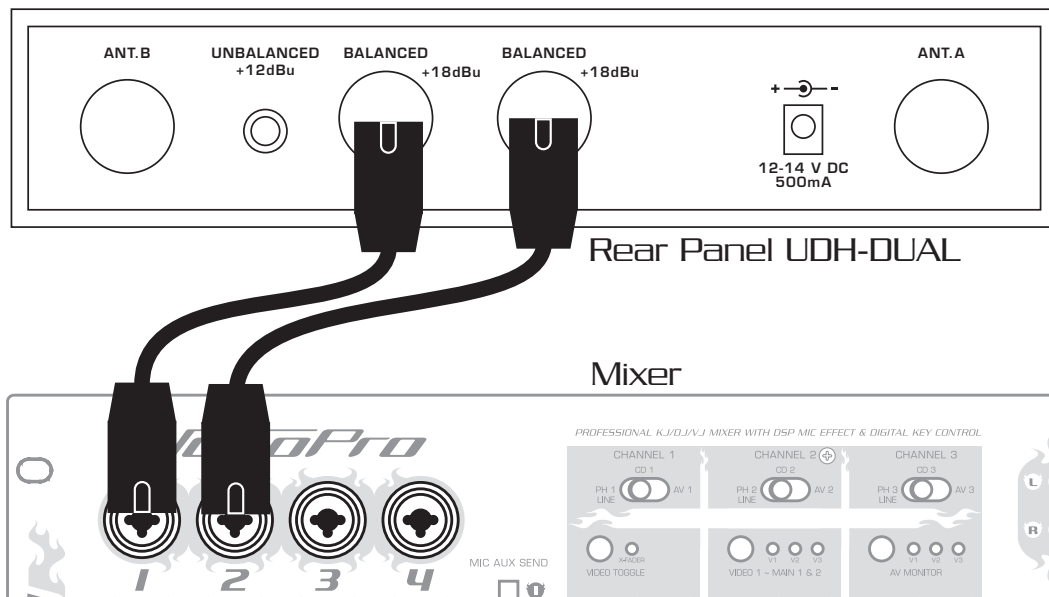

### UNBALANCED 1/4"

1. Connect 1 unbalanced 1/4" cable (included) to the Unbalanced output from the UDH receiver.
2. Connect the other end of the 1/4" cable to a microphone input channel on a mixer.

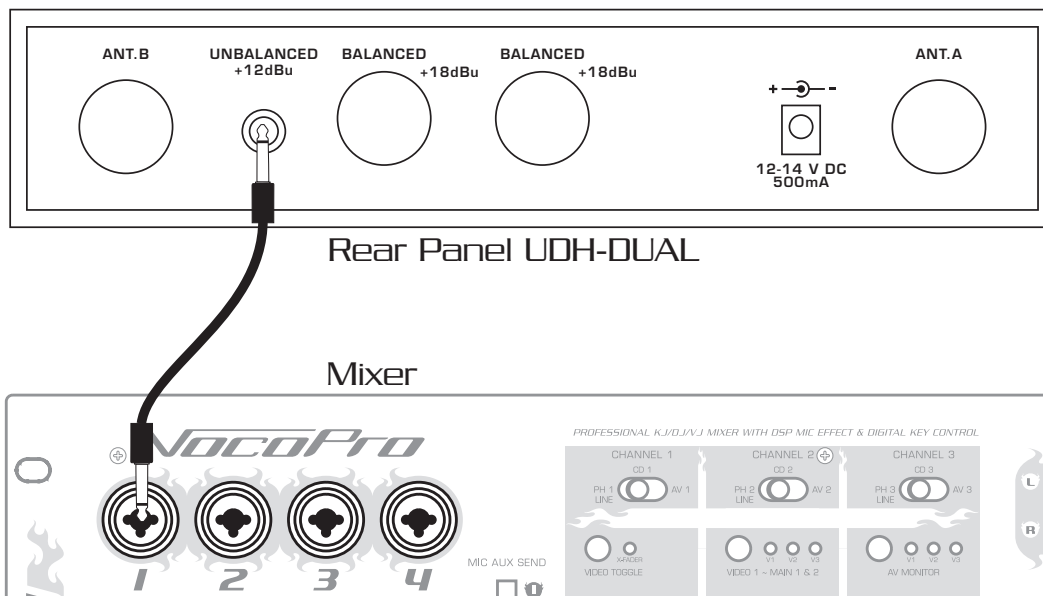

# Getting Connected

## MOUNTING

The UDH-Ultra receivers are already connected together. If, for whatever reason, they need to be reconnected, please follow the steps below.

1. Attach the two UDH receivers together by aligning the tab and slot located on each side.
2. Slide the two receivers together to form one UDH-Ultra receiver.
3. Attach the two smaller brackets to either end of the UDH-Ultra receiver.

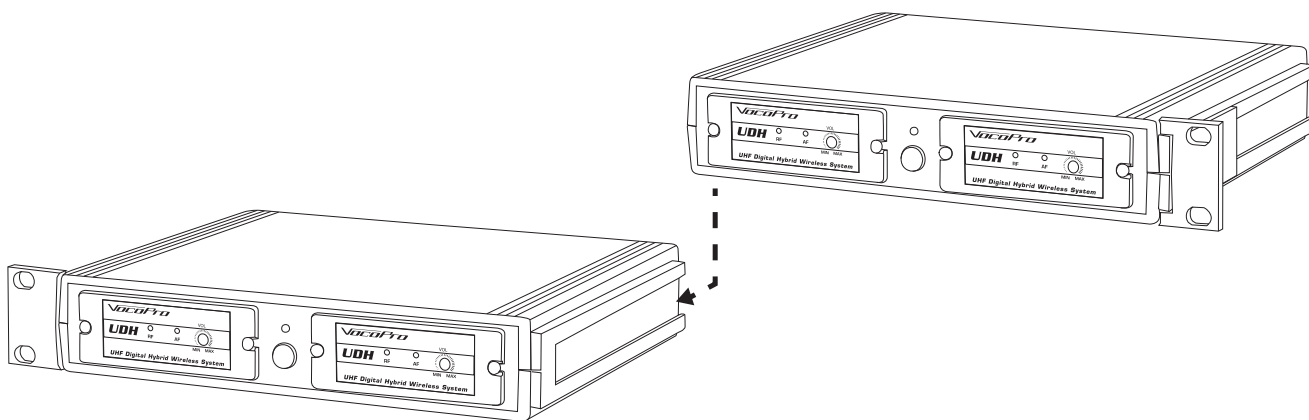

## USING THE HEADSET, LAVALIERE, AND INSTRUMENT CABLE

The UDH-Ultra bodypacks can accept audio from either the headset microphone, lavalier microphone, or an instrument. They would all connect to the same Mini-XLR input jack located at the top of the UDH bodypacks.

**Note:** The instrument cable is intended for equipment with a line-level mono signal, such as a guitar or bass.

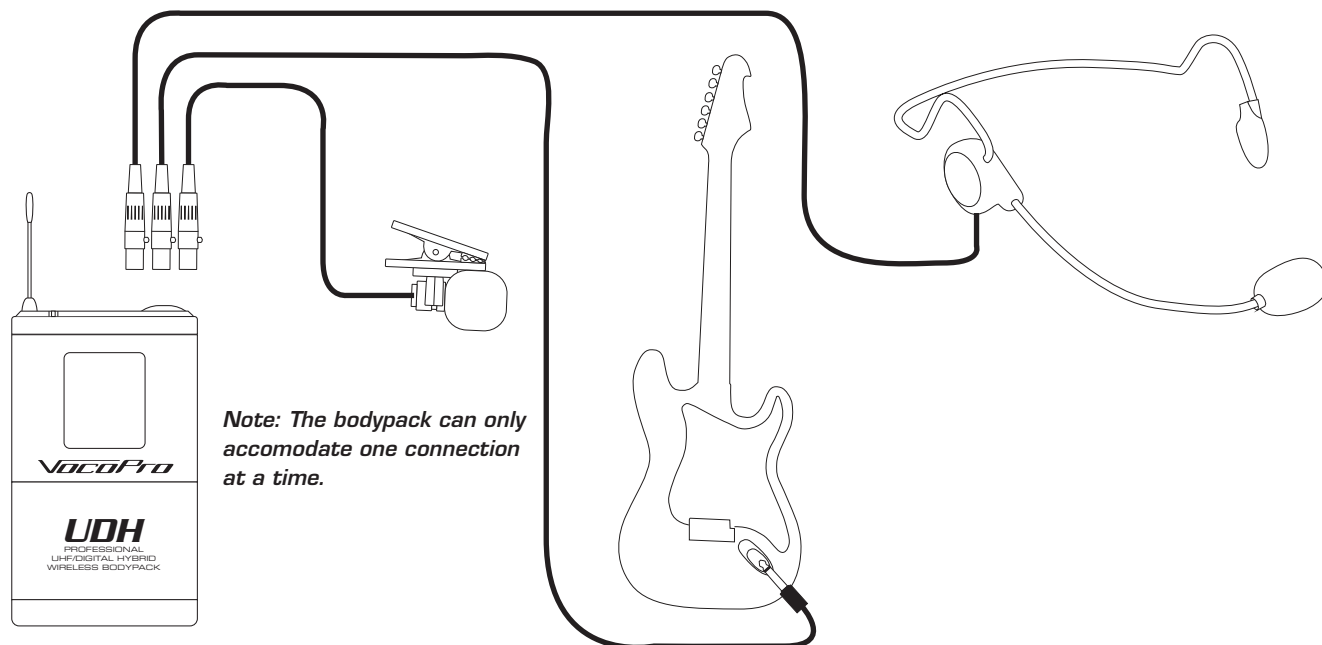

# Commonly Asked Questions

## **1. What do I do if my Mics are cutting in and out?**

- Make sure both antennas are firmly attached to their posts.
- Keep the receiver away from fluorescent lights.
- Make sure microphones are being used within the operational range.
- Ensure batteries are not depleted.

## **2. There's a thumping noise coming through the speakers, what is it?**

- This typically occurs when the batteries are low.
- Less likely, it may be the power supply not providing the correct power. Try a suitable replacement adapter with same values to confirm.
- If problem persists, please call Vocopro for further instructions.

## **3. The lights on the receiver are flashing off and on continuously, what's going on?**

- Ensure the correct power supply is used with the UDH.
- Inspect power supply cable for frayed wires or loose connections.
- Find a suitable replacement for the original power supply; contact Vocopro for factory original parts at 800-678-5348.

## **4. What type of instruments can I use with the instrument cable & bodypack?**

- Any instrument that uses a mono line-level signal..
- A stereo instrument such as a keyboard will be incompatible.

